

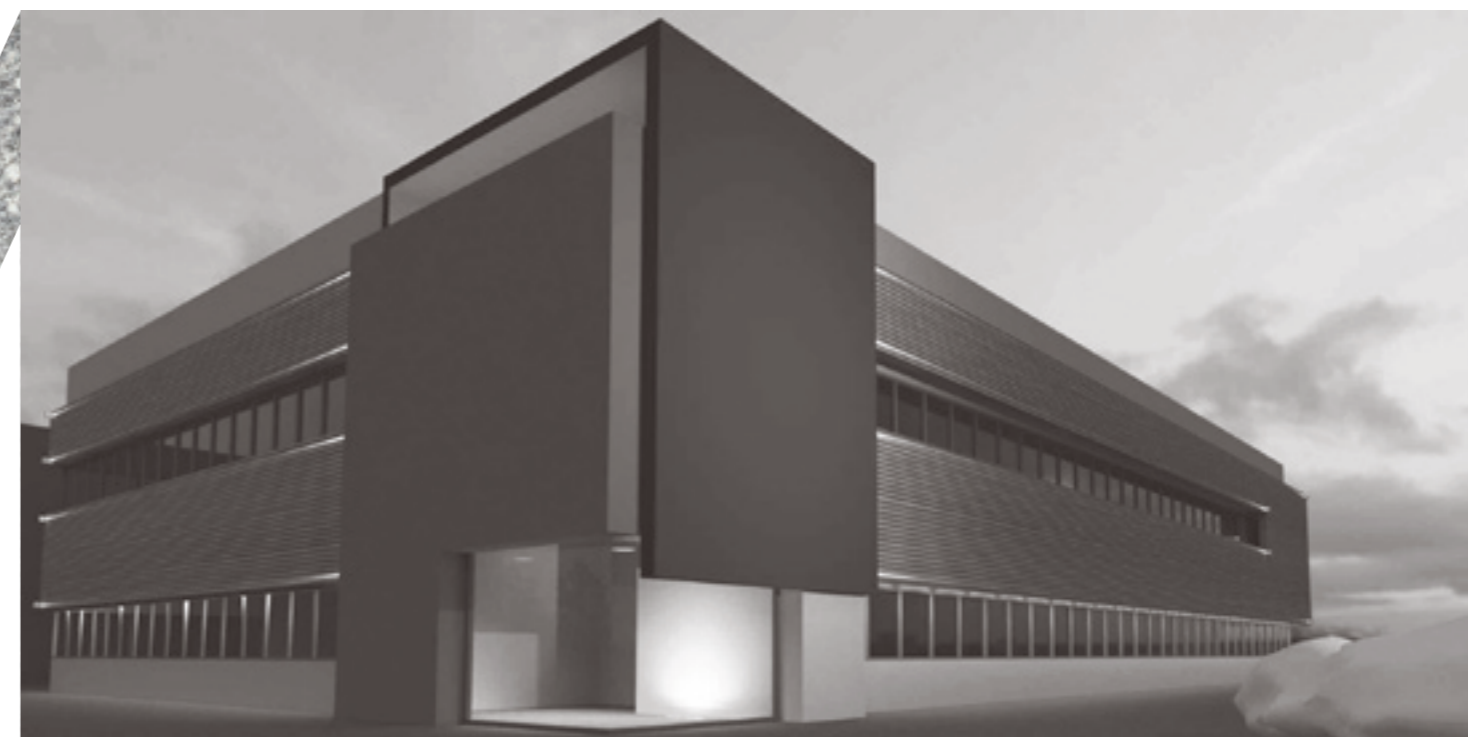

*Una storia
consolidata
nel tempo*



In ROBERTO MARELLA S.p.A. la maniglia rappresenta un "luogo particolare". E' un oggetto privilegiato che non si limita ad essere risposta funzionale, ma esprime, nella materia e nella forma, il piacere estetico di un semplice gesto.

ROBERTO MARELLA S.p.A. mantiene e sviluppa una Leadership sul mercato nazionale e internazionale, diventando l'unica azienda italiana con una produzione **100% Made in Italy**, completa e specializzata nella produzione di maniglie e accessori per cucina, bagno e mobile, con un'ampia gamma prodotta sempre più completa in stile e design.

In Roberto Marella S.p.A., the handle represents this "particular place". It's a privileged object, not only a functional response, it represents, in its features, the esthetical pleasure of a simple gesture.

ROBERTO MARELLA S.p.A. maintains and develops the Leadership on National and International market, becoming the only Italian company with a **completely 100% Made in Italy** production process, complete and specialized in the production of handles and accessories for kitchens, bathrooms and furniture, with a wide range of products even more complete in Style and Design.

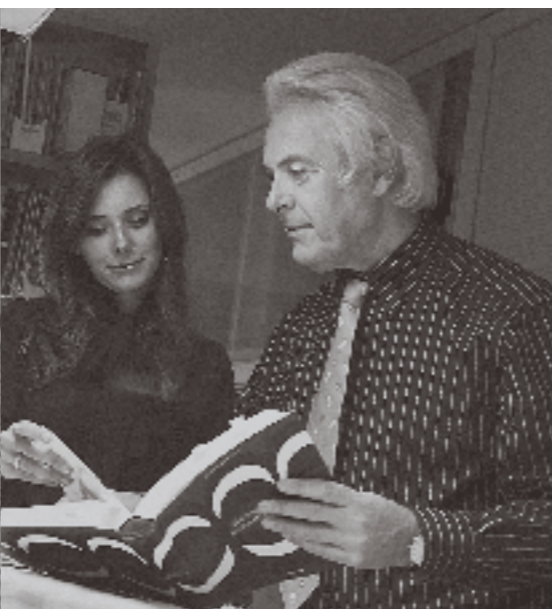

MARCO BORTOLIN

Terminati gli studi di arredamento e di interior design, matura esperienze nel campo del design industriale in qualità di designer ed art director nel mercato italiano, negli Stati Uniti ed attualmente anche nel mercato Russo.

In collaborazione con Roberto Marella ha creato una nuova linea di maniglie moderne a marchio Marella Design, in cui emerge tutta la sua abilità artistica e l'eccellenza del Made in Italy, simbolo di qualità, ricerca, innovazione e originalità.

Upon graduation in interior design, he acquired experience in the field of industrial design as designer and art director in Italy, as well as in the United States and, currently, also in the Russian market. In collaboration with Bosetti Marella, he has created a new collection of modern handles, branded Marella Design, where he shows all his artistic skills and the excellence of Made in Italy, symbol of quality, research, innovation and originality.

GHEORG SEEBACHER

"La curiosità è alla base della comprensione; è perciò essenziale vedere le persone come utilizzatori finali. Dobbiamo cercare di capire i loro valori, contesti culturali e le loro richieste, come future possibilità tecnologiche e collegare, infine, tutti questi aspetti. Attraverso questa comprensione, aspiro, con passione, a sviluppare concetti e implementarli, creando prodotti affascinanti in grado di soddisfare tanto le richieste emozionali quanto quelle funzionali."

"Curiosity forms the basis of understanding. It is therefore essential to see people as users.

We must seek to understand their values, cultural backgrounds, and demands as future technological possibilities and also connect all of these aspects. With this understanding, I passionately aspire to develop concepts and to implement them by creating fascinating products that meet emotional as well as functional requirements."

BALUTTO STUDIO

Un atelier in continuo fermento, laboratorio creativo ed officina di produzione, Fondato da Adriano Balutto, più volte nominato -"designer di best seller"-, si è arricchito da qualche anno di un nuovo apporto creativo, l'Arch. Veronica Balutto.

L'attività dello studio Balutto è stata premiata svariate volte con prestigiosi riconoscimenti a livello internazionale. Studio Balutto, an ever moving, creative lab and production workshop. Adriano Balutto is the founder and has been appointed as "Designer of Bestseller" several times; For some years, the new presence of the Architect Veronica Balutto, conveyed a new creative contribution. The Balutto atelier activity has been awarded several times with prestigious international identification.

ALESSANDRO ELLI

Nasce in Brianza nel 1968, dopo il diploma, frequenta la SPD di Milano seguendo il Master in Disegno Industriale. Le aziende con cui collabora o ha collaborato sono: Axil, Bross, Di Liddo & Perego, Emmemobili, I Carraro, Linfa, Nespoli - Consonni, Salcon imbottiti, Servetto, Pamar, YDF, Thrrre. La collezione Cubik progettata per Di Liddo & Perego vince il "premio speciale Tiziana Mascheroni" nell'ambito del concorso Yung & Design 2005.

Was born in Brianza in 1968, after the diploma, attended the SPD in Milan following the Master in Industrial Design. The companies with which it collaborates or has collaborated are: Axil, Bross, Di Liddo & Perego, Emmemobili, I Carraro, Linfa, Nespoli - Consonni, Salcon imbottiti, Servetto, Pamar, YDF, thrrre. The Cubik collection designed for Di Liddo & Perego won the "Special Award Tiziana Mascheroni" within the Yung & Design 2005 contest.creativity.

MICHELE FAINI

"In uno scenario sempre più competitivo nella ricerca, ma appiattito nel gusto, cerco di riportare i miei progetti alle radici della nostra cultura. Il mio obiettivo è soddisfare un bisogno, tenendo conto della ricerca del bello, dell'armonia e dell'estetica, unite alla funzionalità e all'utilità.

Siamo geneticamente padroni di fascino ed eleganza, grazie a secoli di fastosa cultura artistica posta agli apici del mondo: la capacità di voltarsi indietro per andare avanti è, a mio parere, la marcia in più che porta a nuove strade di creatività pura."

"In a period, increasingly competitive in the research, but flattened in the style, I try to bring my projects to the roots of our culture. My goal is to satisfy a need, taking into consideration the research of beauty, harmony and aesthetics, combined with the functionality and usefulness of products. Thanks to our artistic culture placed at the apex of the world, We are genetically owners of charm and elegance: The ability to look back, for going on, is, in my opinion, the extra edge leading to new avenues of pure creativity."

Barocca

DESIGN: MICHELE FAINI

Serie realizzabile in tutte le finiture indicate a catalogo / Series available in all finishes in the catalogue.

C.29

Finitura / Finish: 07 - Oro di Valenza



15179Z32020.07

15179Z19220.07

15179Z12820.07

24179Z02000.07

CODICE <i>Code</i>	MISURE <i>Overall size</i>	INTERASSE <i>C. to C.</i>
15179Z32020	344x21x40	320-256
15179Z19220	211x18x34	192-160
15179Z12820	145x14x28	128-096
24179Z02000	20x17x24	-

Bridge

DESIGN: MARELLA DESIGN LAB



Serie realizzabile in tutte le finiture indicate a catalogo / Series available in all finishes in the catalogue.

C.37

Finitura / Finish: 91 - Pewter

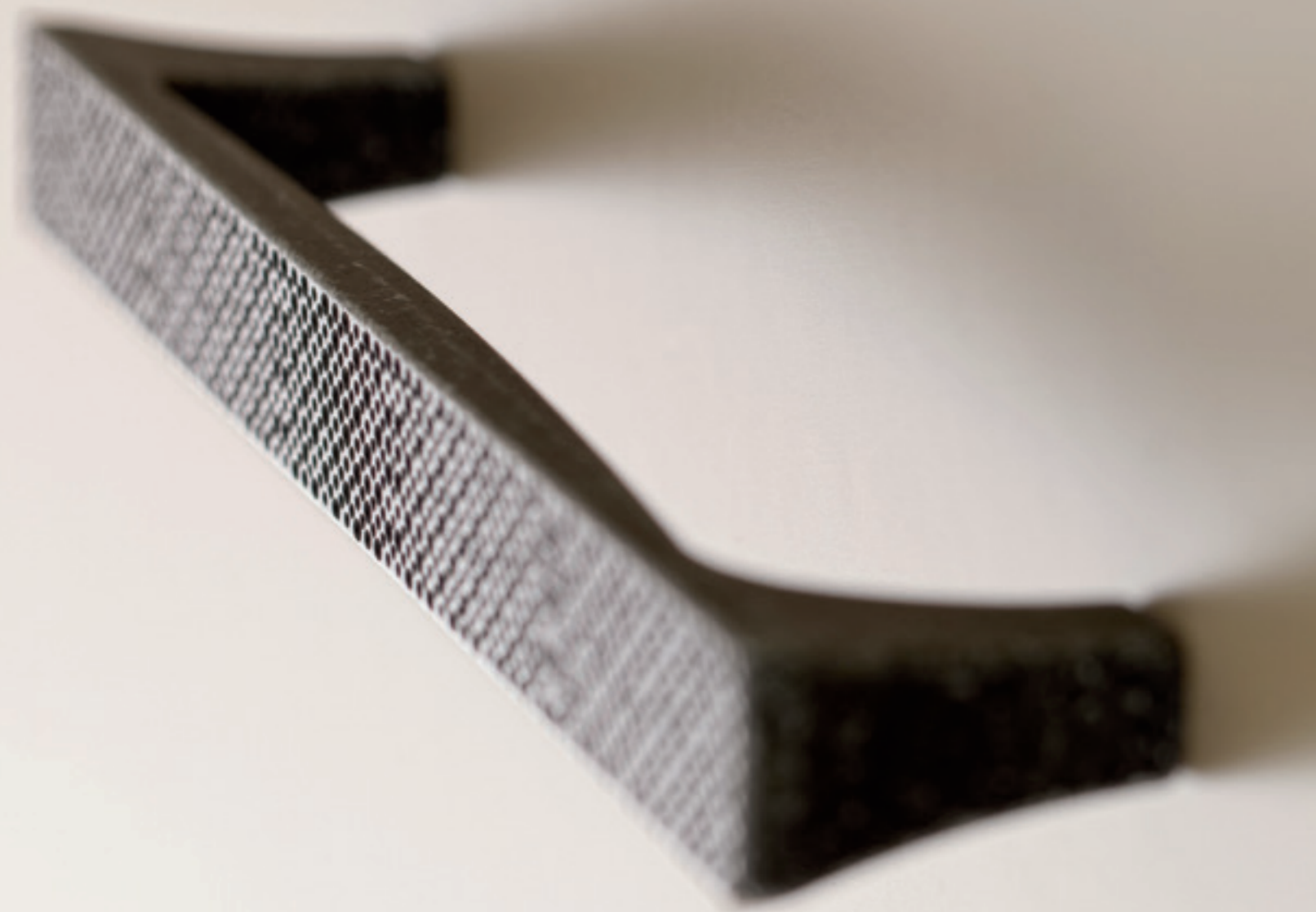

15162Z12800.91

24162Z03200.91

CODICE <i>Code</i>	MISURE <i>Overall size</i>	INTERASSE <i>C. to C.</i>
15162Z12800	144x15x28	128
24162Z03200	32x15x28	16



Finitura / Finish: 94 - Iron effect



Finitura / Finish: 09 - Florence

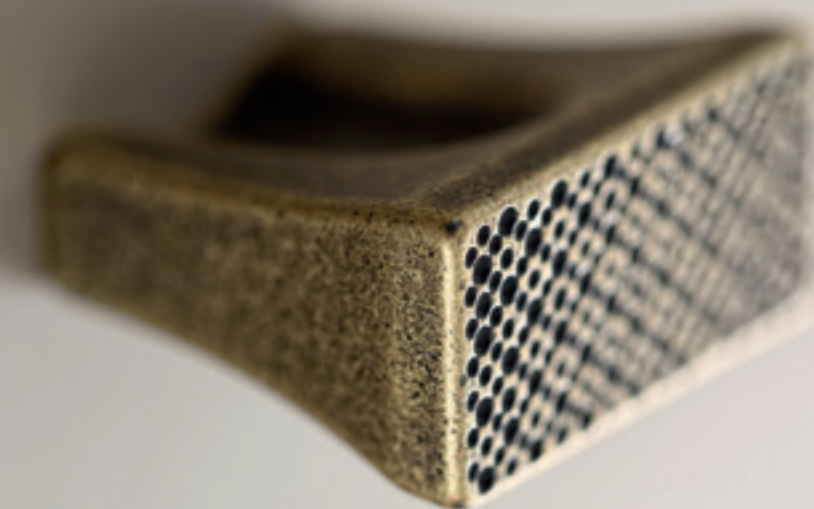



Intreccio

DESIGN: BALUTTO STUDIO ASSOCIATI

Serie realizzabile in tutte le finiture indicate a catalogo / Series available in all finishes in the catalogue.

C.57

Finitura / Finish: 07 - Oro di Valenza



15213Z09600.07



24213Z04500.07

CODICE
Code

15213Z09600
24213Z04500

MISURE
Overall size

142x73x30
45x45x22

INTERASSE
C. to C.

96
-

Finitura / Finish: 19 - Similferro / Similiron

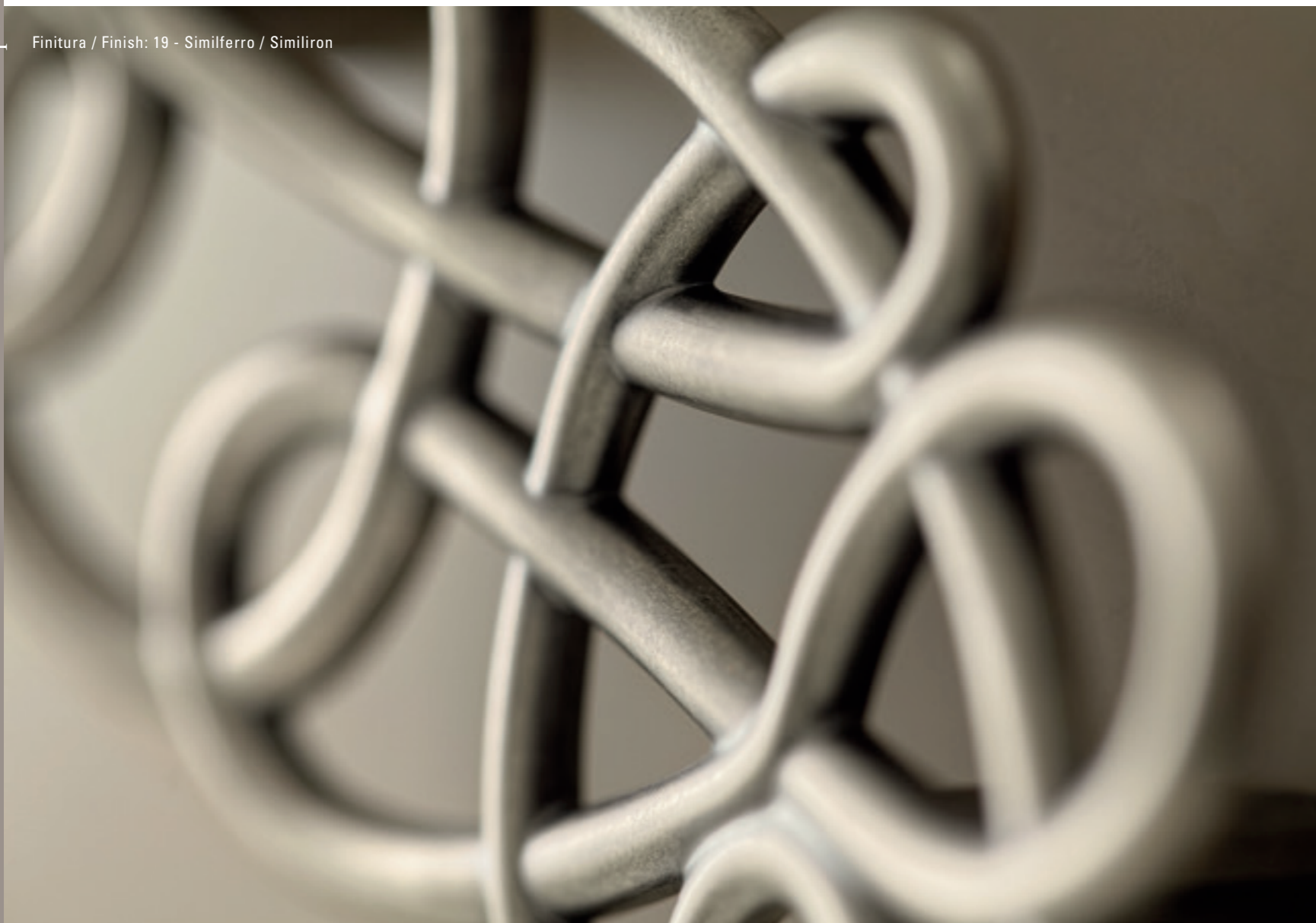

Finitura / Finish: 36 Cromo lucido / Bright chrome



Autumn

DESIGN: BALUTTO STUDIO ASSOCIATI

Serie realizzabile in tutte le finiture indicate a catalogo / Series available in all finishes in the catalogue.

C.61

Finitura / Finish: 25 - Argento vecchio / Old silver



15229Z12800.25



24229Z02800.25

CODICE
Code

15229Z12800
24229Z02800

MISURE
Overall size

176x28x26
28x28x25

INTERASSE
C. to C.

128
-



Tudor

DESIGN: BALUTTO STUDIO ASSOCIATI

Serie realizzabile in tutte le finiture indicate a catalogo / Series available in all finishes in the catalogue.

C.65

Finitura / Finish: 22 - Old America



15231Z16000.22

24231Z03200.22

CODICE
Code

15231Z16000
24231Z03200

MISURE
Overall size

175x24x39
32x32x29

INTERASSE
C. to C.

160
-

Finitura / Finish: 36 - Cromo lucido / Bright chrome



Finitura / Finish: 91 - Pewter



Laguna



DESIGN: MARELLA DESIGN LAB

Serie realizzabile in tutte le finiture indicate a catalogo / Series available in all finishes in the catalogue.

C.73

Finitura / Finish: 36- Cromo lucido / Bright chrome



Contemporaneo

CODICE <i>Code</i>	MISURE <i>Overall size</i>	INTERASSE <i>C. to C.</i>
15076Z32020	353x32x39	288 - 320
15076Z12800	196x27x31	128
15076Z09620	154x25x30	96 - 128
15076Z05800	21x58x28	-

Finitura / Finish: 36 - Cromo lucido / Bright chrome



Finitura / Finish:



C.75

Contemporaneo

www.paghardware.com

Oasi

DESIGN: MARELLA DESIGN LAB

Serie realizzabile in tutte le finiture indicate a catalogo / Series available in all finishes in the catalogue.

Finitura / Finish: 25 - Argento vecchio / Old silver



Oasi

DESIGN: MARELLA DESIGN LAB

Serie realizzabile in tutte le finiture indicate a catalogo / Series available in all finishes in the catalogue.

Finitura / Finish: 36 - Cromo lucido / Bright chrome



CODICE <i>Code</i>	MISURE <i>Overall size</i>	INTERASSE <i>C.to C.</i>
15159Z16000	200x33x26	160
15159Z09600	137x33x26	96
24159Z03400	34x33x26	-

CODICE <i>Code</i>	MISURE <i>Overall size</i>	INTERASSE <i>C.to C.</i>
15160Z12800	150x52x27	128
15160Z06400	84x87x27	64
24160Z03200	48x52x27	32

Oasi

DESIGN: MARELLA DESIGN LAB

Serie realizzabile in tutte le finiture indicate a catalogo / *Series available in all finishes in the catalogue.*

Finitura / Finish: 36 - Cromo lucido / Bright chrome



15161Z12800.36

15161Z06400.36

Oasi

DESIGN: MARELLA DESIGN LAB

Serie realizzabile in tutte le finiture indicate a catalogo / *Series available in all finishes in the catalogue.*

Finitura / Finish: 36 - Cromo lucido / Bright chrome



43161Z12500.36

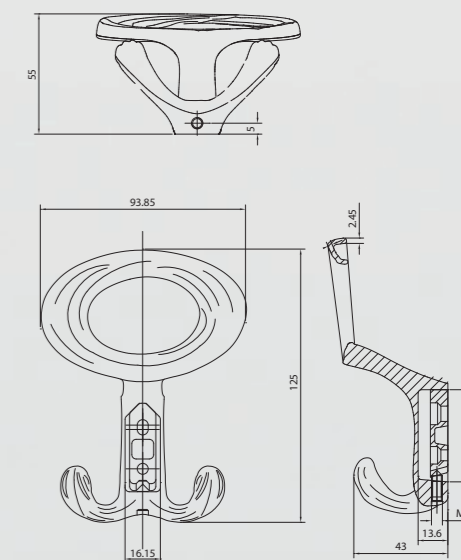

CODICE <i>Code</i>	MISURE <i>Overall size</i>	INTERASSE <i>C. to C.</i>
15161Z12800	151x64x27	128
15161Z06400	83x82x27	64

CODICE <i>Code</i>	MISURE <i>Overall size</i>	INTERASSE <i>C. to C.</i>
43161Z12500	94x125x55	-

Oasi incasso / inset

DESIGN: MARELLA DESIGN LAB

Serie realizzabile in tutte le finiture indicate a catalogo / Series available in all finishes in the catalogue.

C.87

Finitura / Finish: 36 - Cromo lucido / Bright chrome



15160Z20900.36



15160Z14500.36



15160Z11300.36

CODICE <i>Code</i>	MISURE <i>Overall size</i>	INTERASSE <i>C.to C.</i>
15160Z20900	209x56	192
15160Z14500	145x56	128
15160Z11300	113x56	96

Disponibili disegni tecnici per l'incasso
Technical drawings available for the recession

Pandora con smalto/whit émail

DESIGN: MARELLA DESIGN LAB

Serie realizzabile in tutte le finiture indicate a catalogo / Series available in all finishes in the catalogue.

Pandora

DESIGN: MARELLA DESIGN LAB

Serie realizzabile in tutte le finiture indicate a catalogo / Series available in all finishes in the catalogue.

PAGI™

Finitura / Finish: 09 - Firenze con smalto champagne / Florence with enamel champagne

Finitura / Finish: 25 - Argento vecchio / Old silver



15177Z12800L09



24177Z05800L09



24177Z03000L09



15177Z12800.25



24177Z05800.25



24177Z03000.25

CODICE <i>Code</i>	MISURE <i>Overall size</i>	INTERASSE <i>C.to C.</i>
15177Z12800	161x32x30	128
24177Z05800	58x32x26	-
24177Z03000	30x21	Ø 30

CODICE <i>Code</i>	MISURE <i>Overall size</i>	INTERASSE <i>C.to C.</i>
15177Z12800	161x32x30	128
24177Z05800	58x32x26	-
24177Z03000	30x21	Ø 30



Stone

DESIGN: MARELLA DESIGN LAB

Serie realizzabile in tutte le finiture indicate a catalogo / Series available in all finishes in the catalogue.

C.99

Finitura / Finish: 25 - Argento vecchio / Old silver



15256Z12800.25



24256Z04900.25



15256Z06400.25

CODICE <i>Code</i>	MISURE <i>Overall size</i>	INTERASSE <i>C.to C.</i>
15256Z12800	194x57x28	128
15256Z06400	98x55x28	64
24256Z04900	49x46x28	-

Daphne

DESIGN: MARELLA DESIGN LAB

Serie realizzabile in tutte le finiture indicate a catalogo / Series available in all finishes in the catalogue.

C.101

Finitura / Finish: 78 - Bagno Argento / Silver plated



15078Z064S0.78

15078Z064D0.78

15078Z032D0.78

15078Z032S0.78

CODICE <i>Code</i>	MISURE <i>Overall size</i>	INTERASSE <i>C.to C.</i>
15078Z064S0	149x56x28	64
15078Z064D0	149x56x28	64
15078Z032S0	107x36x18	32
15078Z032D0	107x36x18	32



Eden

DESIGN: MARELLA DESIGN LAB

Serie realizzabile in tutte le finiture indicate a catalogo / Series available in all finishes in the catalogue.

C.105

Finitura / Finish: 47 - Argento Orientale / Oriental silver



15079Z06400.47



15079Z03200.47

CODICE <i>Code</i>	MISURE <i>Overall size</i>	INTERASSE <i>C.to C.</i>
15079Z06400	98x72x23	64
15079Z03200	72x53x19	32

Floris

DESIGN: MARELLA DESIGN LAB

Serie realizzabile in tutte le finiture indicate a catalogo / Series available in all finishes in the catalogue.

C.107

Finitura / Finish: 36 - Cromo lucido / Bright chrome



15163Z10000.36



15163Z06000.36

CODICE <i>Code</i>	MISURE <i>Overall size</i>	INTERASSE <i>C.to C.</i>
15163Z10000	99x100x22	32
15163Z06000	58x60x22	32

Folie

DESIGN: MARELLA DESIGN LAB

Serie realizzabile in tutte le finiture indicate a catalogo / Series available in all finishes in the catalogue.

Folie

DESIGN: MARELLA DESIGN LAB

Serie realizzabile in tutte le finiture indicate a catalogo / Series available in all finishes in the catalogue.

PAGI™

Finitura / Finish: 07 - Oro di Valenza

Finitura / Finish: 07 - Oro di Valenza



CODICE <i>Code</i>	MISURE <i>Overall size</i>	INTERASSE <i>C.to C.</i>
15375Z128S0	160x83x29	128
15375Z096S0	124x65x25	96

CODICE <i>Code</i>	MISURE <i>Overall size</i>	INTERASSE <i>C.to C.</i>
15375Z128D0	160x83x29	128
15375Z096D0	124x65x25	96



Sole

DESIGN: MARELLA DESIGN LAB



Serie realizzabile in tutte le finiture indicate a catalogo / Series available in all finishes in the catalogue.

C.113

Finitura / Finish: 47 - Argento orientale / Oriental silver



24157Z06900.47



15157Z06900.47



24157Z05000.47



15157Z05000.47



24157Z03000.47

CODICE <i>Code</i>	MISURE <i>Overall size</i>	INTERASSE <i>C.to C.</i>
15157Z06900	69x35x24	32
15157Z05000	50x26x22	16
24157Z06900	69x24	int. 32 - Ø 39
24157Z05000	50x22	int. 16 - Ø 50
24157Z03000	30x20	Ø 30



Zar

DESIGN: MARELLA DESIGN LAB

Serie realizzabile in tutte le finiture indicate a catalogo / Series available in all finishes in the catalogue.

Zar

DESIGN: MARELLA DESIGN LAB

Serie realizzabile in tutte le finiture indicate a catalogo / Series available in all finishes in the catalogue.

PAGI

Finitura / Finish: 25 - Argento vecchio / Old silver

Finitura / Finish: 25 - Argento vecchio / Old silver



15258Z09600.25



15258Z13400.25



30258Z060V0.25



33728Z0420N.25



24258Z09900.25



24258Z07900.25



24258Z06000.25

CODICE Code	MISURE Overall size	INTERASSE C.to C.
15258Z09600	164x52x28	96
15258Z13400	134x45x15	96
30258Z060V0	33x60	-
33728Z0420N	29x77	42

CODICE Code	MISURE Overall size	INTERASSE C.to C.
24258Z09900	99x52x27	32
24258Z07900	79x41x25	32
24258Z06000	60x33x25	-



Alhambra

DESIGN: MARELLA DESIGN LAB

Serie realizzabile in tutte le finiture indicate a catalogo / Series available in all finishes in the catalogue.

C.119

Finitura / Finish: 09 - Florence



03158.07300.09



03158.05400.09



30158.040V0.09



33718.0420N.09

CODICE <i>Code</i>	MISURE <i>Overall size</i>	INTERASSE <i>C. to C.</i>
03158.07300	48x73x15	-
03158.05400	34x54x15	-
30158.040V0	28x40	-
33718.0420N	24x69	42

Viaggio

DESIGN: MARELLA DESIGN LAB

Serie realizzabile in tutte le finiture indicate a catalogo / Series available in all finishes in the catalogue.

PAGITM

Viaggio

DESIGN: MARELLA DESIGN LAB

Serie realizzabile in tutte le finiture indicate a catalogo / Series available in all finishes in the catalogue.

Finitura / Finish: 25 - Argento Vecchio / Old silver

Finitura / Finish: 47 - Argento orientale / Oriental silver



CODICE Code	MISURE Overall size	INTERASSE C. to C.
15050Z12800	151x27x28	128
15050Z05900	24x70x25	-
24250Z07300	73x31x24	32

CODICE Code	MISURE Overall size	INTERASSE C. to C.
15054Z16000	200x22x28	160
15054Z12800	163x22x28	128
24083Z03000	30x23	Ø 30
24083Z02500	25x21	Ø 25

Arabesque

DESIGN: MARELLA DESIGN LAB

Serie realizzabile in tutte le finiture indicate a catalogo / Series available in all finishes in the catalogue.

C.129

Finitura / Finish: 32 - Nickel lucido / Bright nickel



15072Z27300.32

15072Z12800.32

15072Z06400.32

24172Z04700.32

CODICE <i>Code</i>	MISURE <i>Overall size</i>	INTERASSE <i>C. to C.</i>
15072Z27300	290x55x36	273
15072Z12800	142x50x27	128
15072Z06400	79x50x25	64
24172Z04700	47x38x24	-

Capriccio

DESIGN: MARELLA DESIGN LAB

Serie realizzabile in tutte le finiture indicate a catalogo / Series available in all finishes in the catalogue.

Capriccio

DESIGN: MARELLA DESIGN LAB

Serie realizzabile in tutte le finiture indicate a catalogo / Series available in all finishes in the catalogue.

PAGITM

Finitura / Finish: 36 - Cromo lucido / Bright chrome

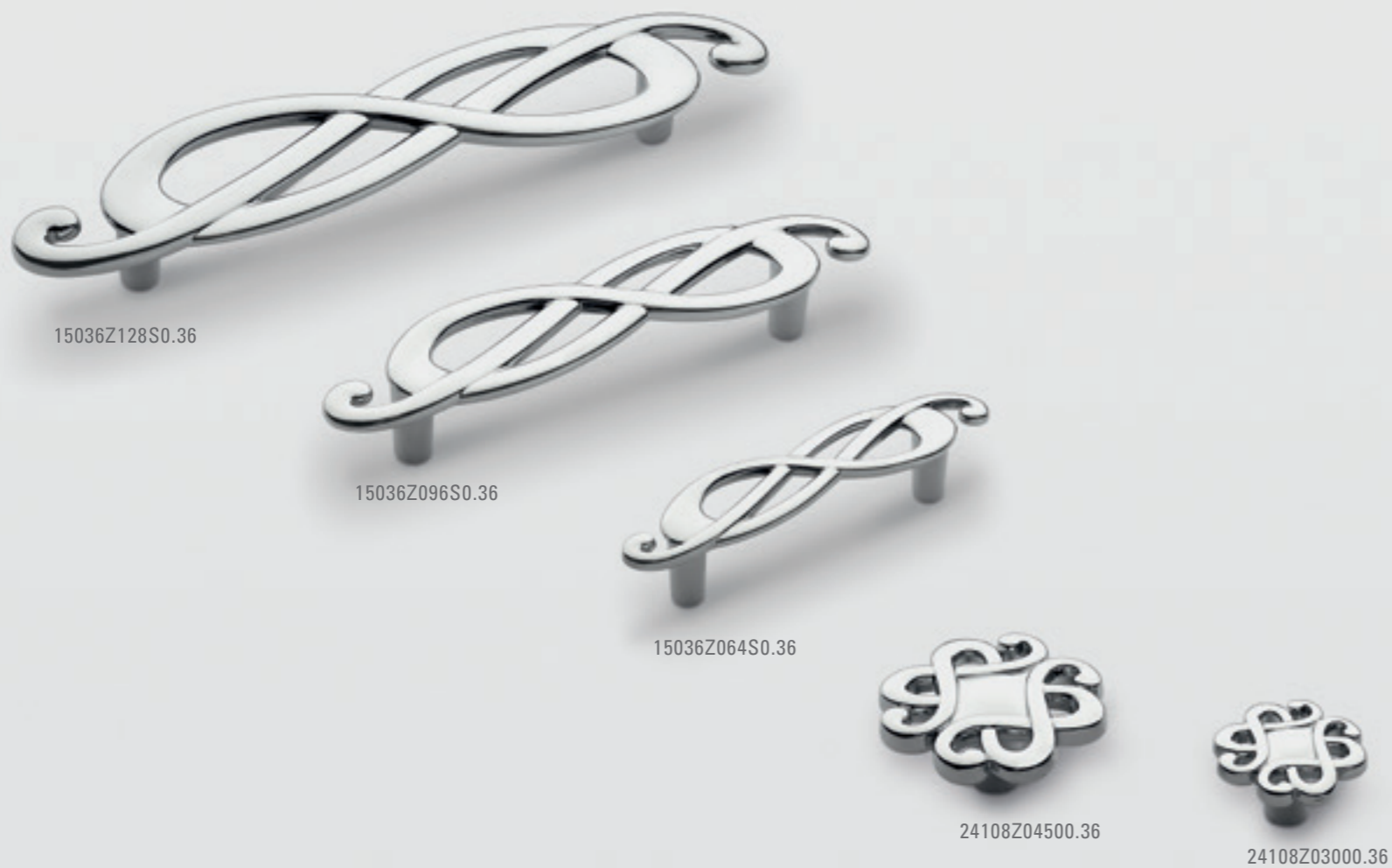

Finitura / Finish: 36 - Cromo lucido / Bright chrome



CODICE Code	MISURE Overall size	INTERASSE C.to C.
15036Z128S0	185x44x28	128
15036Z096S0	138x32x27	96
15036Z064S0	95x22x24	64
24108Z04500	45x24	Ø 45
24108Z03000	30x20	Ø 30

CODICE Code	MISURE Overall size	INTERASSE C.to C.
15036Z128D0	185x44x28	128
15036Z096D0	138x32x27	96
15036Z064D0	95x22x24	64
30236Z101V0	22x101	-

CODICE Code	MISURE Overall size	INTERASSE C.to C.
30236Z10100	101x23	-
33108.0340N	67x30	34
33108.0420N	75x30	42



Capriccio

DESIGN: MARELLA DESIGN LAB

Serie realizzabile in tutte le finiture indicate a catalogo / Series available in all finishes in the catalogue.



Finitura / Finish: 07 - Oro di Valenza



CODICE Code	MISURE Overall size	INTERASSE C.to C.
15308Z12800	177x45x30	128
15308Z09600	126x30x26	96
24108Z04500	45x45x24	Ø 45
24108Z03000	30x30x20	Ø 30
30236Z101V0	23x101	-

CODICE Code	MISURE Overall size	INTERASSE C.to C.
30236Z10100	101x22	-
33108.0340N	67x30	34
33108.0420N	75x30	42

Forme

DESIGN: MARELLA DESIGN LAB

Serie realizzabile in tutte le finiture indicate a catalogo / Series available in all finishes in the catalogue.

C.141

Finitura / Finish: 07 - Oro di Valenza



15125Z12800.07



15125Z06400.07

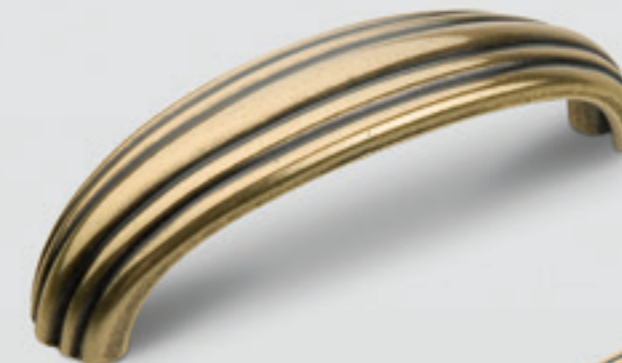

15125Z09600.07



24125Z04700.07

CODICE <i>Code</i>	MISURE <i>Overall size</i>	INTERASSE <i>C. to C.</i>
15125Z12800	141x32x31	128
15125Z09600	110x30x31	96
15125Z06400	77x25x20	64
24125Z04700	47x21x24	-

Forme

DESIGN: MARELLA DESIGN LAB

Serie realizzabile in tutte le finiture indicate a catalogo / Series available in all finishes in the catalogue.

C.151

Finitura / Finish: 19 - Similferro / Similiron

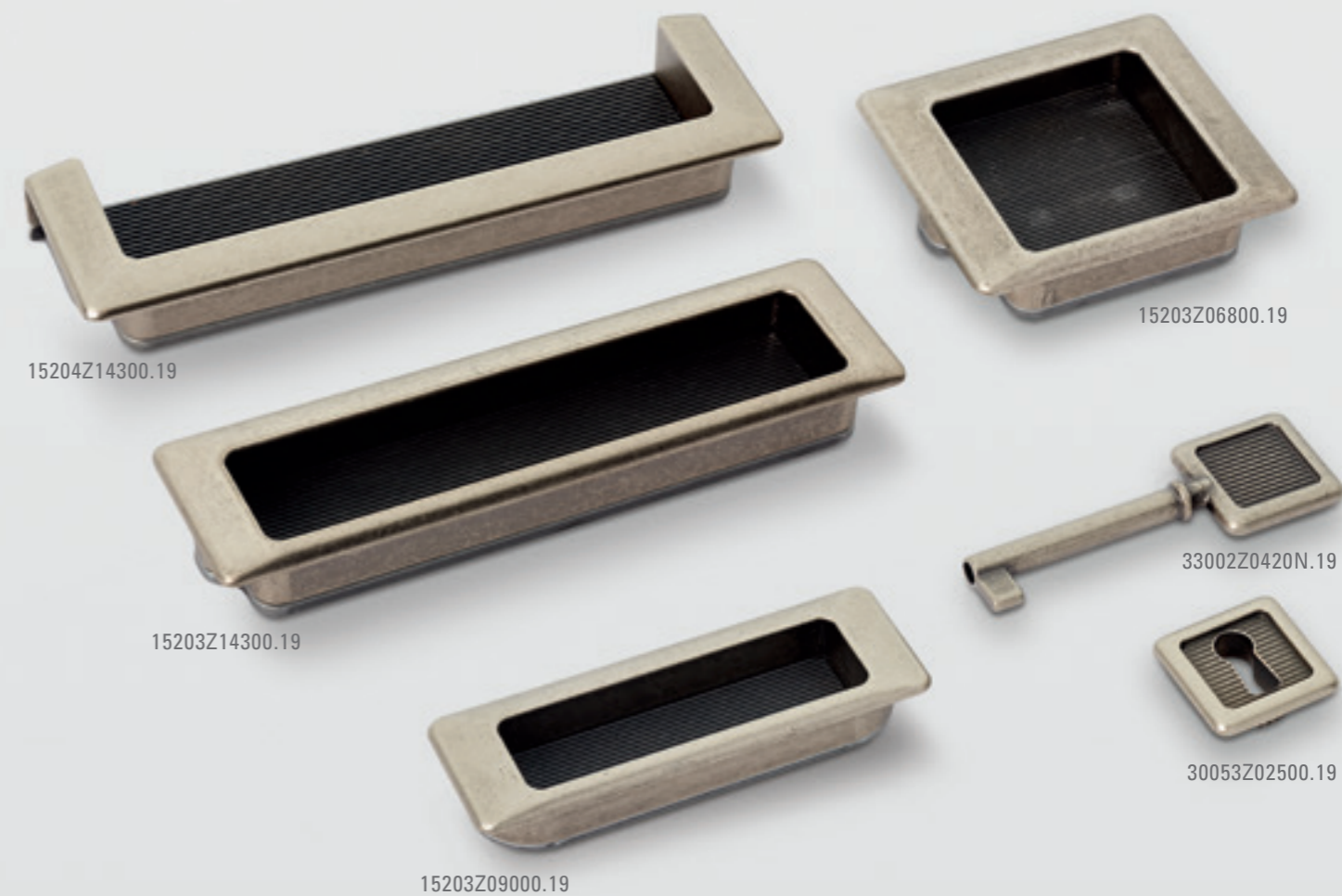

CODICE <i>Code</i>	MISURE <i>Overall size</i>	INTERASSE <i>C.to C.</i>
15204Z14300	143x40	128
15203Z14300	143x40	128
15203Z09000	90x31	75
15203Z06800	68x60	53
33002Z0420N	25x72	42
30053Z02500	25x25	-

Disponibili disegni tecnici per l'incasso
Technical drawings available for the recession

Natura

DESIGN: MARELLA DESIGN LAB

Serie realizzabile in tutte le finiture indicate a catalogo / Series available in all finishes in the catalogue.

Finitura / Finish: 36 - Cromo lucido / Bright chrome



15057Z12800.36



15057Z09600.36



15057Z10000.36

CODICE <i>Code</i>	MISURE <i>Overall size</i>	INTERASSE <i>C. to C.</i>
15057Z12800	182x40x29	128
15057Z09600	150x40x27	96
15057Z10000	98x43x26	64

Natura

DESIGN: MARELLA DESIGN LAB

Serie realizzabile in tutte le finiture indicate a catalogo / Series available in all finishes in the catalogue.

Natura

DESIGN: MARELLA DESIGN LAB

Serie realizzabile in tutte le finiture indicate a catalogo / Series available in all finishes in the catalogue.

PAGITM

Finitura / Finish: 25 - Argento vecchio / Old silver

Finitura / Finish: 09 - Florence

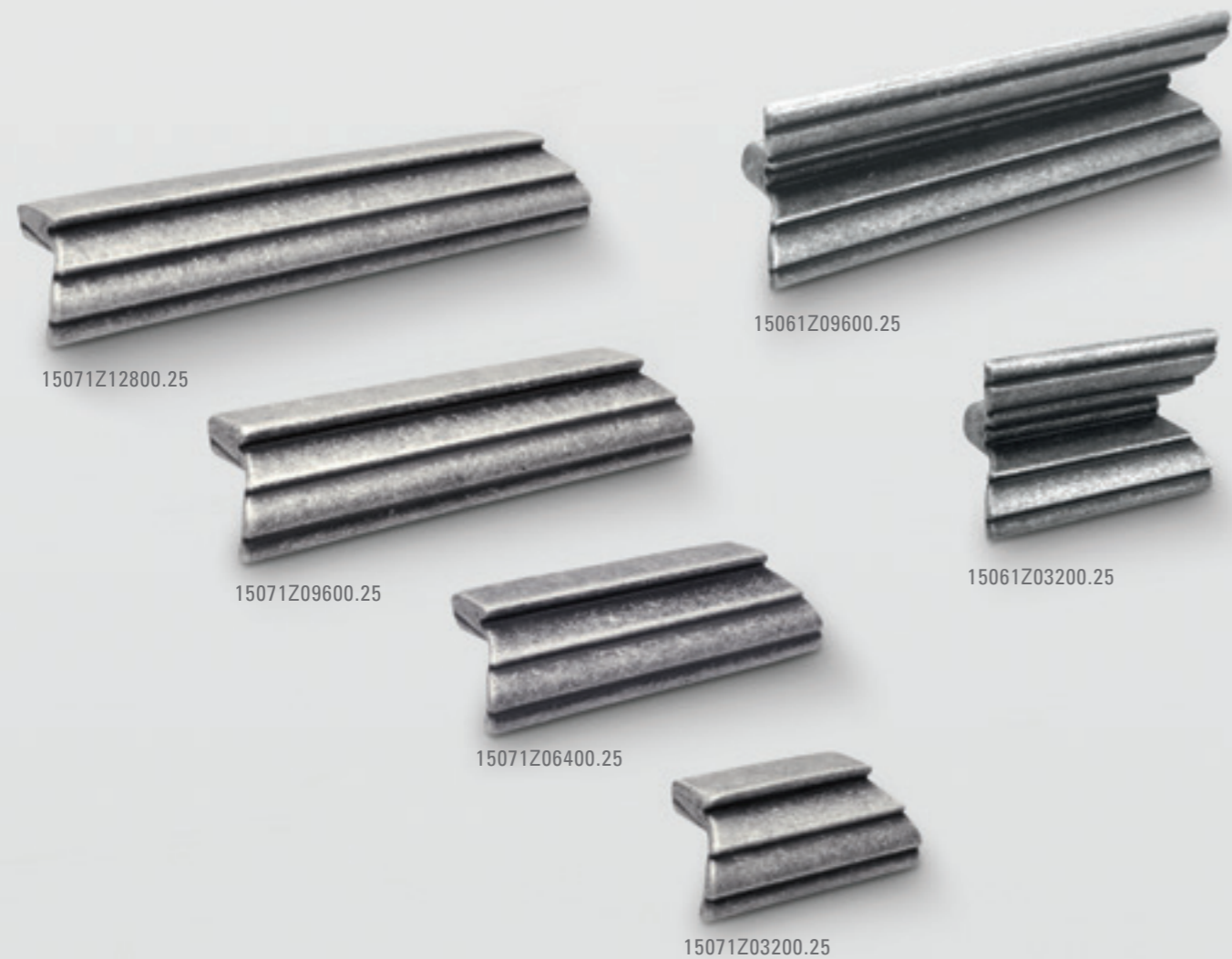

CODICE <i>Code</i>	MISURE <i>Overall size</i>	INTERASSE <i>C.to C.</i>
15071Z12800	154x20x22	128
15071Z09600	122x20x22	96
15071Z06400	89x20x22	64
15071Z03200	58x20x22	32
15061Z09600	122x36x22	96
15061Z03200	58x36x22	32

CODICE <i>Code</i>	MISURE <i>Overall size</i>	INTERASSE <i>C.to C.</i>
15051Z09600	120x50x29	96
15051Z06400	88x51x25	64
15051Z04500	35x46x24	-



Oriente

DESIGN: MARELLA DESIGN LAB

Serie realizzabile in tutte le finiture indicate a catalogo / Series available in all finishes in the catalogue.

C.159

Finitura / Finish: 19 - Similferro / Similiron



15086Z12800.19

15086Z09600.19

24086Z03500.19

15086Z04900.19

CODICE <i>Code</i>	MISURE <i>Overall size</i>	INTERASSE <i>C.to C.</i>
15086Z12800	159x29x31	128
15086Z09600	127x29x29	96
15086Z04900	25x49x26	-
24086Z03500	34x25x20	-

Oriente

DESIGN: MARELLA DESIGN LAB

Serie realizzabile in tutte le finiture indicate a catalogo / Series available in all finishes in the catalogue.

C.161

Finitura / Finish: 25 - Argento vecchio / Old silver



15085Z12800.25

15085Z09600.25

15085Z06400.25

24085Z03500.25

CODICE <i>Code</i>	MISURE <i>Overall size</i>	INTERASSE <i>C. to C.</i>
15085Z12800	163x27x27	128
15085Z09600	131x26x27	96
15085Z06400	99x25x27	64
24085Z03500	35x21x21	-

Sensazioni

DESIGN: MARELLA DESIGN LAB

Serie realizzabile in tutte le finiture indicate a catalogo / Series available in all finishes in the catalogue.

C.169

Finitura / Finish: 07 - Oro Valenza



15083Z16000.07



15083Z12800.07



15083Z09600.07



15067Z06400.07



24083Z03000.07



24083Z02500.07

CODICE <i>Code</i>	MISURE <i>Overall size</i>	INTERASSE <i>C.to C.</i>
15083Z16000	182x35x30	160
15083Z12800	149x30x29	128
15083Z09600	113x27x27	96
15067Z06400	102x36x22	64
24083Z03000	30x23	Ø 30
24083Z02500	25x21	Ø 25

Sensazioni

DESIGN: MARELLA DESIGN LAB

Serie realizzabile in tutte le finiture indicate a catalogo / Series available in all finishes in the catalogue.

Finitura / Finish: 09 - Florence



15064Z09600.09

24064Z03000.09

15064Z06400.09

24064Z05200.09

Sensazioni

DESIGN: MARELLA DESIGN LAB

Serie realizzabile in tutte le finiture indicate a catalogo / Series available in all finishes in the catalogue.

Colore smalto / Enamel color: Arancio-Rosso / Orange-Red
Finitura / Finish: 32 Nickel lucido / Bright nickel

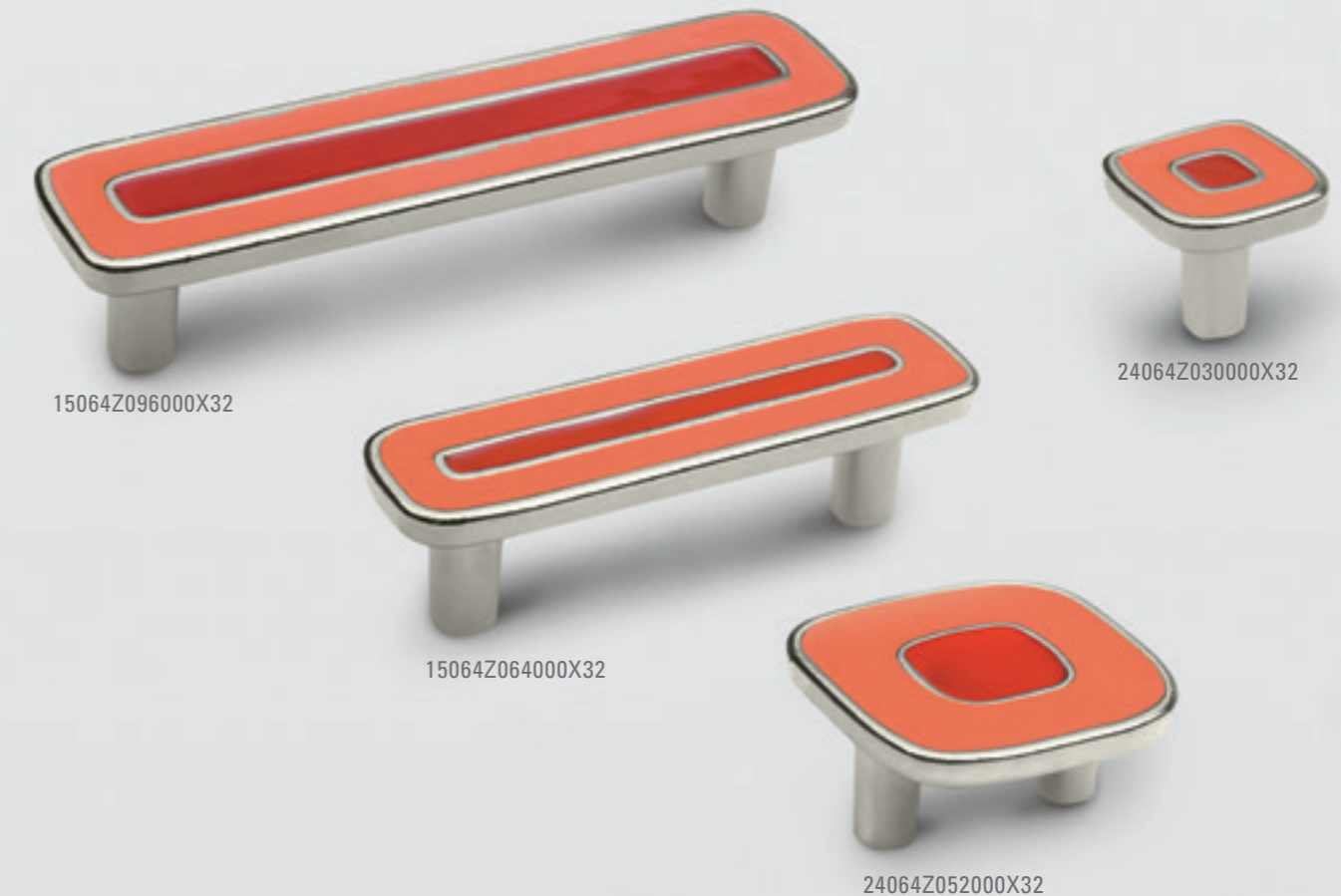

15064Z096000X32

24064Z030000X32

15064Z064000X32

24064Z052000X32

CODICE Code	MISURE Overall size	INTERASSE C. to C.
15064Z09600	122x30x25	96
15064Z06400	90x26x25	64
24064Z05200	52x52x26	32
24064Z03000	30x30x26	-



15064Z06400Y32

Colore smalto / Enamel color: Y Giallo-Verde / Yellow-Green
Finitura / Finish: 32 Nickel lucido / Bright Nickel



15064Z06400J32

Colore smalto / Enamel color: J Rosa-Rosa chiaro / Pink-Light Pink
Finitura / Finish: 32 Nickel lucido / Bright Nickel

www.paghardware.com



Profili

DESIGN: MARELLA DESIGN LAB

Serie realizzabile in tutte le finiture indicate a catalogo / Series available in all finishes in the catalogue.

C.175

Finitura / Finish: 09 - Florence



15084Z16000.09



15084Z12800.09



15084Z09600.09



24084Z04500.09



15084Z06800.09

CODICE <i>Code</i>	MISURE <i>Overall size</i>	INTERASSE <i>C.to C.</i>
15084Z16000	176x33x30	160
15084Z12800	142x29x28	128
15084Z09600	120x28x27	96
15084Z06800	25x68x26	-
24084Z04500	45x25x22	-



Profili

DESIGN: MARELLA DESIGN LAB



Serie realizzabile in tutte le finiture indicate a catalogo / Series available in all finishes in the catalogue.

C.181

Finitura / Finish: 19 - Similferro / Similiron

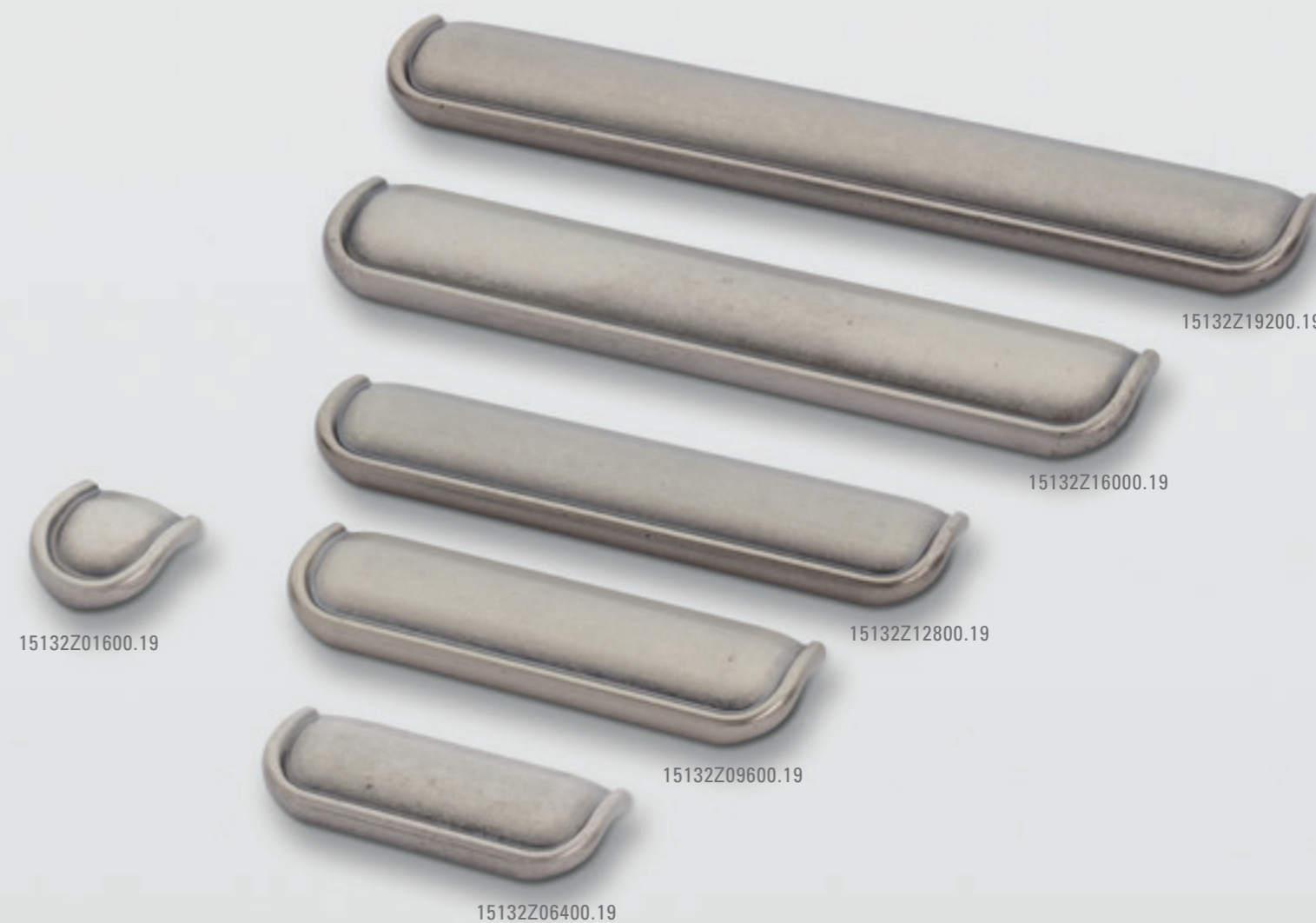

Contemporaneo

CODICE <i>Code</i>	MISURE <i>Overall size</i>	INTERASSE <i>C.to C.</i>
15132Z19200	204x29x18	192
15132Z16000	172x29x18	160
15132Z12800	140x29x18	128
15132Z09600	108x29x18	96
15132Z06400	76x29x18	64
15132Z01600	28x29x18	-

Varietà

DESIGN: MARELLA DESIGN LAB

Serie realizzabile in tutte le finiture indicate a catalogo / Series available in all finishes in the catalogue.

C.187

Finitura / Finish: 25 - Argento vecchio / Old silver



Contemporaneo

CODICE <i>Code</i>	MISURE <i>Overall size</i>	INTERASSE <i>C.to C.</i>
15045Z09600	154x28x26	96
15045Z06400	103x20x22	64
15045Z07800	84x48x24	64
15045Z06800	21x68x26	-
24073Z02600	26x26x20	-

Varietà

DESIGN: MARELLA DESIGN LAB

Serie realizzabile in tutte le finiture indicate a catalogo / Series available in all finishes in the catalogue.

Finitura / Finish: 19 - Similferro / Similiron



15133Z12800.19



15133Z09500.19



15133Z09600.19



15133Z07000.19

CODICE <i>Code</i>	MISURE <i>Overall size</i>	INTERASSE <i>C. to C.</i>
15133Z12800	170x29x29	128
15133Z09600	138x27x26	96
15133Z09500	97x52x24	64
15133Z07000	28x70x25	-

Eco pelle / Eco leather

DESIGN: MARELLA DESIGN LAB

Serie realizzabile in tutte le finiture indicate a catalogo / Series available in all finishes in the catalogue.

Finitura / Finish: 25 - Argento vecchio / Old Silver
Ecopelle / Ecoleather: Nero / Black



15175E12890.25



21175E11390.25

Cuoio / Leather

DESIGN: MARELLA DESIGN LAB

Serie realizzabile in tutte le finiture indicate a catalogo / Series available in all finishes in the catalogue.

Finitura / Finish: 07 - Oro di Valenza



15150.12800.07



15150.09600.07



21150.03800.07



30150.04700



30150.047V0

CODICE Code	MISURE Overall size	INTERASSE C.to C.
15175E12890.25	202x37	128
21175E11390.25	111x37	-

CODICE Code	MISURE Overall size	INTERASSE C.to C.
15150.12800	195x37	128
15150.09600	160x37	96
21150.03800	37x52	-
30150.047V0	27x47	-
30150.04700	47x27	-

Art Dèco

Serie realizzabile in tutte le finiture indicate a catalogo / Series available in all finishes in the catalogue.

Art Dèco con smalto/With enamel



Serie realizzabile in tutte le finiture indicate a catalogo / Series available in all finishes in the catalogue.

Finitura / Finish: 09 - Florence

Finitura / Finish: L09 - Florence con smalto champagne / Florence with champagne



CODICE Code	MISURE Overall size	INTERASSE C.to C.
15134Z12800	141x30	128
15134Z10000	102x34	64
24134Z07300	73x31x23	32
24134Z03000	30x22	Ø 30

CODICE Code	MISURE Overall size	INTERASSE C.to C.
15134Z12800	141x30	128
15134Z10000	102x34	64
24134Z07300	73x31x23	32
24134Z03000	30x22	Ø 30

Arts & Crafts

Serie realizzabile in tutte le finiture indicate a catalogo / Series available in all finishes in the catalogue.

Arts & Crafts

Serie realizzabile in tutte le finiture indicate a catalogo / Series available in all finishes in the catalogue.



Finitura / Finish: 09 - Florence



15146Z16000.09

15146Z12800.09

15146Z09600.09

Finitura / Finish: 09 - Florence



15144Z12800.09

15144Z09600.09

15144Z06400.09

15144Z03800.09

CODICE <i>Code</i>	MISURE <i>Overall size</i>	INTERASSE <i>C.to C.</i>
15146Z16000	198x32	160
15146Z12800	166x32	128
15146Z09600	134x32	96

CODICE <i>Code</i>	MISURE <i>Overall size</i>	INTERASSE <i>C.to C.</i>
15144Z12800	165x38	128
15144Z09600	131x38	96
15144Z06400	100x37	64
15144Z03800	38x36	-

Arts & Crafts

Serie realizzabile in tutte le finiture indicate a catalogo / Series available in all finishes in the catalogue.

Arts & Crafts

Serie realizzabile in tutte le finiture indicate a catalogo / Series available in all finishes in the catalogue.



Finitura / Finish: 25 - Argento vecchio / Old silver

Finitura / Finish: 09 - Florence

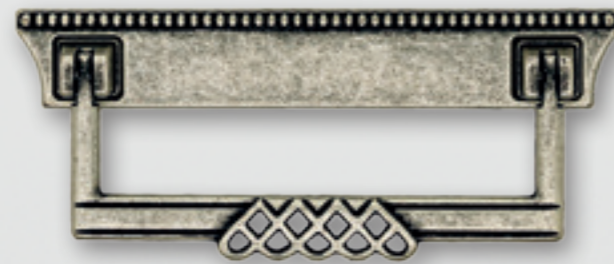

06144Z09600.25



03144Z09600.25



45144Z09000.09



15144Z10000.09



24144Z05000.09



30144Z090V0.09

CODICE Code	MISURE Overall size	INTERASSE C. to C.
06144Z09600	123x19	96
03144Z09600	109x44	96

CODICE Code	MISURE Overall size	INTERASSE C. to C.
15144Z10000	100x35	64
24144Z05000	50x23x19	-
30144Z090V0	22x90	-
45144Z09000	90x27	-

Art Dèco

Serie realizzabile in tutte le finiture indicate a catalogo / Series available in all finishes in the catalogue.

Art Dèco

Serie realizzabile in tutte le finiture indicate a catalogo / Series available in all finishes in the catalogue.



Finitura / Finish: 54 - Patinè bm

Finitura / Finish: 07 - Oro di Valenza



18330.18500.54

18330.12800.54

18330.09000.54



15129Z09600.07

15129Z06400.07

CODICE Code	MISURE Overall size	INTERASSE C. to C.
18330.18500	37x213	185
18330.12800	27x149	128
18330.09000	23x110	90

CODICE Code	MISURE Overall size	INTERASSE C. to C.
15129Z09600	120x17	96
15129Z06400	86x14	64

Art Dèco

Serie realizzabile in tutte le finiture indicate a catalogo / Series available in all finishes in the catalogue.

Art Dèco

Serie realizzabile in tutte le finiture indicate a catalogo / Series available in all finishes in the catalogue.



Finitura / Finish: 09 - Florence
03 - Ottone antico / Antique brass

Finitura / Finish: 09 - Florence
19 - Similferro / Similiron



15104.08500.09



15104.06000.09



15138.08000.03



15138.08000.19



15139.08000.27



15103Z09000.19

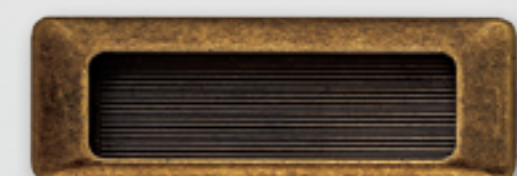

15203Z09000.09

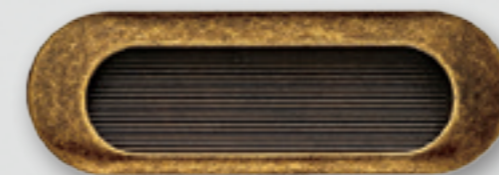

15103Z09000.09



15203Z09000.19

CODICE Code	MISURE Overall size	INTERASSE C.to C.
15104.08500	27x85	-
15104.06000	27x60	-
15138.08000	26x80	-
15139.08000	26x80	-

CODICE Code	MISURE Overall size	INTERASSE C.to C.
15103Z09000	90x31	75
15203Z09000	90x31	75





Barocco

Serie realizzabile in tutte le finiture indicate a catalogo / Series available in all finishes in the catalogue.

Finitura / Finish: 54 - Patinè bm



09015.08300.54



30631.062V0.54



24452Z03500.54



24452Z03000.54



09015.06200.54



30631.06200.54





24452Z02500.54



33723.0420N.54



24452Z02000.54

CODICE <i>Code</i>	MISURE <i>Overall size</i>	INTERASSE <i>C. to C.</i>	CODICE <i>Code</i>	MISURE <i>Overall size</i>	INTERASSE <i>C. to C.</i>
09015.08300	83x69	-	30631.06200	62x29	-
09015.06200	62x52	-	30631.062V0	29x62	-
24452Z03500	35x28	Ø 35	33723.0420N	28x88	N 42 
24452Z03000	30x26	Ø 30	33723.0340N	28x80	N 34 
24452Z02500	25x23	Ø 25			
24452Z02000	20x21	Ø 20			

Barocco

Serie realizzabile in tutte le finiture indicate a catalogo / Series available in all finishes in the catalogue.

Barocco

Serie realizzabile in tutte le finiture indicate a catalogo / Series available in all finishes in the catalogue.

PAGITM

Finitura / Finish: 07 - Oro di Valenza

Finitura / Finish: 07 - Oro di Valenza



15117Z09600.07

15117Z06400.07

24260Z03000.07

30730Z050V0.07

33716Z0340N.07

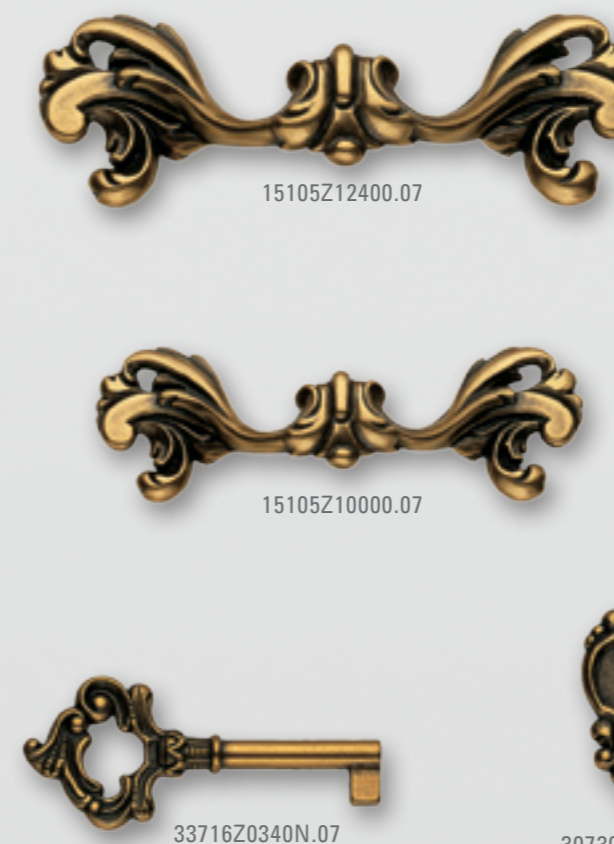

15105Z12400.07

15105Z10000.07

33716Z0340N.07



21803Z06000.07

22006Z12500.07

24260Z03000.07

CODICE Code	MISURE Overall size	INTERASSE C.to C.
15117Z09600	162x20	96
15117Z06400	108x14	64
24260Z03000	31x25x18	-
30730Z050V0	29x51	-
33716Z0340N	32x73	N 34 

CODICE Code	MISURE Overall size	INTERASSE C.to C.
15105Z12400	124x40	64
15105Z10000	100x32	64
21803Z06000	20x70	-
22006Z12500	28x125	-

CODICE Code	MISURE Overall size	INTERASSE C.to C.
24260Z03000	31x25x18	-
30730Z050V0	29x50	-
33716Z0340N	32x73	N 34 

Coloniale

Serie realizzabile in tutte le finiture indicate a catalogo / Series available in all finishes in the catalogue.

Finitura / Finish: 09 - Florence



15147Z12800.09



15147Z10000.09



15147Z09600.09



24147Z07300.09

CODICE <i>Code</i>	MISURE <i>Overall size</i>	INTERASSE <i>C. to C.</i>
15147Z12800	190x35	128
15147Z10000	102x34	64
15147Z09600	154x35	96
24147Z07300	73x31x23	32

Neoclassico

Serie realizzabile in tutte le finiture indicate a catalogo / Series available in all finishes in the catalogue.

Neoclassico

Serie realizzabile in tutte le finiture indicate a catalogo / Series available in all finishes in the catalogue.



C.272

C.273

Stile

Finitura / Finish: 07 - Oro di Valenza



15115Z09600.07



15115Z06400.07



03049Z09600.07



03049Z06400.07



24221Z03000.07



24221Z02500.07



30606Z039V0.07

21801Z05800.07

Finitura / Finish: 07 - Oro di Valenza



22801Z13500.07



22801Z11000.07



22801Z13501.07



22801Z11001.07

Stile

CODICE Code	MISURE Overall size	INTERASSE C.to C.
03049Z09600	123x51	96
03049Z06400	84x35	64
15115Z09600	120x52	96
15115Z06400	82x35	64
21801Z05800	20x68	-

CODICE Code	MISURE Overall size	INTERASSE C.to C.
24221Z03000	30x22	Ø 30
24221Z02500	25x20	Ø 25
30606Z039V0	18x40	-

CODICE Code	MISURE Overall size	INTERASSE C.to C.
22801Z13500	28x136	-
22801Z13501	28x136	-
22801Z11000	28x111	-
22801Z11001	28x111	-

Neoclassico

Serie realizzabile in tutte le finiture indicate a catalogo / Series available in all finishes in the catalogue.

Neoclassico

Serie realizzabile in tutte le finiture indicate a catalogo / Series available in all finishes in the catalogue.

Finitura / Finish: 09 - Firenze



Finitura / Finish: 19 - Similferro / Similiron



CODICE Code	MISURE Overall size	INTERASSE C.to C.
15130Z12800	138x14	128
15130Z09600	105x12	96
15130Z06400	73x9	64
21009Z04800	20x58	-
22009Z13500	28x136	-

CODICE Code	MISURE Overall size	INTERASSE C.to C.
22009Z11000	28x111	-
24130Z03000	30x22	Ø 30
24130Z02500	25x20	Ø 25

CODICE Code	MISURE Overall size	INTERASSE C.to C.
15230Z09600	105x12	96
18230Z09600	123x24	96

Hepplerwhite

Serie realizzabile in tutte le finiture indicate a catalogo / Series available in all finishes in the catalogue.

Hepplerwhite

Serie realizzabile in tutte le finiture indicate a catalogo / Series available in all finishes in the catalogue.

PAGITM

Finitura / Finish: 54 - Patinè bm

Finitura / Finish: 54 - Patinè bm



06220.06400.54



30713.05400.54



06220.05200.54

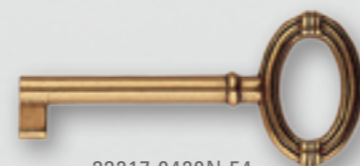

33217.0420N.54



06221.08800.54



06221.07100.54





06221.05300.54



30709.06000.54



33717.0420N.54

CODICE <i>Code</i>	MISURE <i>Overall size</i>	INTERASSE <i>C. to C.</i>
06220.06400	82x62	64
06220.05200	70x51	52
30713.05400	54x35	-
33217.0530N	32x80	N 53 
33217.0420N	32x69	N 42 
33217.0340N	32x61	N 34 

CODICE <i>Code</i>	MISURE <i>Overall size</i>	INTERASSE <i>C. to C.</i>
06221.08800	88x68	32
06221.07100	71x54	32
06221.05300	53x40	-
30709.06000	60x44	-
33717.0420N	25x72	N 42 

Impero

Serie realizzabile in tutte le finiture indicate a catalogo / Series available in all finishes in the catalogue.

Serie realizzabile in tutte le finiture indicate a catalogo / Series available in all finishes in the catalogue.

Finitura / Finish: 54 - Patinè bm

Finitura / Finish: 54 - Patinè bm



12500.08700.54



12500.05800.54



03325.09500.54



03325.07500.54



33717.0420N.54



30616.08000.54



30616.080V0.54



24405.03500.54



24405.03000.54



24405.02500.54



24405.02000.54



CODICE Code	MISURE Overall size	INTERASSE C.to C.
12500.08700	87x50	-
12500.05800	58x33	-

CODICE Code	MISURE Overall size	INTERASSE C.to C.
03325.09500	95x63	32
03325.07500	75x55	32
24405.03500	35x25	Ø 35
24405.03000	30x20	Ø 30
24405.02500	25x17	Ø 25
24405.02000	20x16	Ø 20

CODICE Code	MISURE Overall size	INTERASSE C.to C.
30616.080V0	23x80	-
30616.08000	80x23	-
33717.0420N	25x72	N 42

Liberty

Serie realizzabile in tutte le finiture indicate a catalogo / Series available in all finishes in the catalogue.

Liberty

Serie realizzabile in tutte le finiture indicate a catalogo / Series available in all finishes in the catalogue.

PAGITM

Finitura / Finish: 09 - Firenze

Finitura / Finish: 03 - Ottone antico / Antique brass



CODICE Code	MISURE Overall size	INTERASSE C.to C.
06060Z11200	112x48	64
06060Z09700	97x45	64
12060Z09700	33x97	-
12060Z09701	33x97	-
12060Z05400	33x55	-
30060Z11200	112x38	-

CODICE Code	MISURE Overall size	INTERASSE C.to C.
30060Z09700	97x33	-
30060Z097V0	33x97	-
30060Z035V0	33x35	-

CODICE Code	MISURE Overall size	INTERASSE C.to C.
06331.06400	97x42	64
06331.06401	97x42	64
09229.03200	32x41	-
12237.09700	33x97	-
12237.09701	33x97	-

CODICE Code	MISURE Overall size	INTERASSE C.to C.
30702.097V0	33x97	-
30702.09700	97x33	-

Liberty

Serie realizzabile in tutte le finiture indicate a catalogo / Series available in all finishes in the catalogue.

Liberty

Serie realizzabile in tutte le finiture indicate a catalogo / Series available in all finishes in the catalogue.

PAGITM

Finitura / Finish: 09 - Firenze

Finitura / Finish: 03 - Ottone antico / Antique brass



12326Z09700.09



06332Z06400.09



06332Z06401.09



12326Z03500.09



30712Z09700.09



12326Z09701.09



30712Z097V0.09



18328.06400.03



18328.06401.03



18328.04800.03



18328.04801.03



18328.03200.03



18328.03201.03

CODICE
Code

MISURE
Overall size

INTERASSE
C.to C.

06332Z06400
06332Z06401
12326Z03500
12326Z09700
12326Z09701

97x43
97x43
33x51
33x97
33x97

64
64
-
-
-

CODICE
Code

MISURE
Overall size

INTERASSE
C.to C.

30712Z097V0
30712Z09700

33x97
97x33

-
-

CODICE
Code

MISURE
Overall size

INTERASSE
C.to C.

18328.06401
18328.06400
18328.04801
18328.04800
18328.03201
18328.03200

100x43
100x43
80x35
80x35
60x28
60x28

64
64
48
48
32
32

Luigi XV

Serie realizzabile in tutte le finiture indicate a catalogo / Series available in all finishes in the catalogue.

Finitura / Finish: 54 - Patiné bm



30631.062V0.54

30631.06200.54

15135.11500.54

09204.06000.54

09204.04500.54

33723.0420N.54

24452Z03500.54

24452Z03000.54

24452Z02500.54

24452Z02000.54

CODICE Code	MISURE Overall size	INTERASSE C.to C.	CODICE Code	MISURE Overall size	INTERASSE C.to C.
09204.06000	60x76	-	24452Z02000	20x19	Ø 20
09204.04500	45x57	-	30631.062V0	29x62	-
15135.11500	115x45	64	30631.06200	62x29	-
24452Z03500	35x28	Ø 35	33723.0420N	28x88	N 42
24452Z03000	30x26	Ø 30	33723.0340N	28x80	N 34
24452Z02500	25x23	Ø 25			

Luigi XV

Serie realizzabile in tutte le finiture indicate a catalogo / Series available in all finishes in the catalogue.

Luigi XV

Serie realizzabile in tutte le finiture indicate a catalogo / Series available in all finishes in the catalogue.

Finitura / Finish: 54 - Patinè bm



24452Z03500.54



15107.13600.54



24452Z03000.54



15107.11400.54



24452Z.02500.54



15107.08300.54



24452Z02000.54

Finitura / Finish: 54 - Patinè bm



30605.200S0.54



30605.200D0.54



30605.163S0.54



30605.163D0.54



30605.091S0.54



30605.091D0.54



30605.08500.54



33710.0420N.54

CODICE
Code

MISURE
Overall size

INTERASSE
C.to C.

CODICE
Code

MISURE
Overall size

INTERASSE
C.to C.

CODICE
Code

MISURE
Overall size

INTERASSE
C.to C.

CODICE
Code

MISURE
Overall size

INTERASSE
C.to C.

15107.13600
15107.11400
15107.08300
24452Z03500

136x54
114x44
83x33
35x28

64
64
40
Ø 35

24452Z03000
24452Z02500
24452Z02000

30x26
25x23
20x19

Ø 30
Ø 25
Ø 20

30605.200S0
30605.200D0
30605.163S0
30605.163D0
30605.091S0

26x200
26x200
22x163
22x163
17x91

-
-
-
-
-

30605.091D0
30605.08500
33710.0340N
33710.0420N

17x91
85x24
31x81
33x85

-
-
N 34
N 42

Luigi XV

Serie realizzabile in tutte le finiture indicate a catalogo / Series available in all finishes in the catalogue.

Luigi XV

Serie realizzabile in tutte le finiture indicate a catalogo / Series available in all finishes in the catalogue.



C.334

C.335

Finitura / Finish: 54 - Patinè bm

Finitura / Finish: 25 - Argento vecchio / Old silver



CODICE Code	MISURE Overall size	INTERASSE C.to C.
15109Z09600	159x36	96
15109Z06400	99x25	64
24410Z03500	35x28	Ø 35
24410Z03000	30x24	Ø 30
24410Z02500	25x22	Ø 25

CODICE Code	MISURE Overall size	INTERASSE C.to C.
30631.062V0	29x62	25
30631.06200	62x29	20
30640.148D0	20x148	N 42
30640.148S0	20x148	-
33723.0420N	28x88	N 42
33723.0340N	28x88	N 34

CODICE Code	MISURE Overall size	INTERASSE C.to C.
15106Z17700	177x52	96
15106Z13100	131x39	64



Stile

Stile

Luigi XV

Serie realizzabile in tutte le finiture indicate a catalogo / Series available in all finishes in the catalogue.

Luigi XV

Serie realizzabile in tutte le finiture indicate a catalogo / Series available in all finishes in the catalogue.



Finitura / Finish: 54 - Patinè bm

Finitura / Finish: 54 - Patinè bm



03004.10800.54



24401Z03500.54



24401Z03000.54



35724.04600.54



03004.08700.54



24401Z02500.54



37724.05000.54



03004.07300.54



30639.131S0.54



30639.131D0.54



30639.090S0



30639.090D0



30639.08200.54



33724.0420N.54

CODICE Code	MISURE Overall size	INTERASSE C.to C.
03004.10800	128x51	108
03004.08700	108x45	87
03004.07300	93x38	73
24401Z03500	35x29	Ø 35
24401Z03000	30x24	Ø 30

CODICE Code	MISURE Overall size	INTERASSE C.to C.
24401Z02500	25x23	Ø 25
35724.04600	33x46	-
37724.05000	33x59	-

CODICE Code	MISURE Overall size	INTERASSE C.to C.
30639.08200	81x30	-
30639.090D0	16x90	-
30639.090S0	16x90	-
30639.131D0	23x131	-

CODICE Code	MISURE Overall size	INTERASSE C.to C.
30639.131S0	23x131	-
33724.0420N	33x85	N 42
33724.0340N	33x77	N 34



Luigi XV

Serie realizzabile in tutte le finiture indicate a catalogo / Series available in all finishes in the catalogue.

Luigi XVI

Serie realizzabile in tutte le finiture indicate a catalogo / Series available in all finishes in the catalogue.

Finitura / Finish: 54 - Patinè bm

Finitura / Finish: 54 - Patinè bm
09 - Florence



15331.09600.54



15331.06400.54



30614.071V0.54

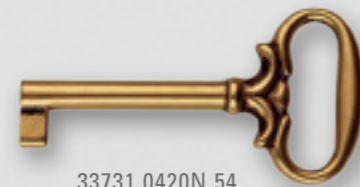

33731.0420N.54



24401Z03500.54



24401Z03000.54



24401Z02500.54



06213.07500.54



06214.08000.54



03213.07500.54



12020Z07200.09

CODICE Code	MISURE Overall size	INTERASSE C.to C.
15331.09600	143x50	96
15331.06400	96x32	64
24401Z03500	35x29	35
24401Z03000	30x24	30
24401Z02500	25x23	25
30614.071V0	15x71	-

CODICE Code	MISURE Overall size	INTERASSE C.to C.
33731.0420N	35x69	N 42 
33731.0340N	35x61	N 34 

CODICE Code	MISURE Overall size	INTERASSE C.to C.
03213.07500	105x60	75
06213.07500	100x65	75
06214.08000	80x60	32
12020Z07200	72x46	32

Luigi XVI

Serie realizzabile in tutte le finiture indicate a catalogo / Series available in all finishes in the catalogue.

Luigi XVI

Serie realizzabile in tutte le finiture indicate a catalogo / Series available in all finishes in the catalogue.

Finitura / Finish: 54 - Patinè bm

Finitura / Finish: 54 - Patinè bm



03050.09600.54



09239.05000.54



03050.06400.54



09239.04200.54



33726.0420N.54



30710.03000.54



09239.03400.54



22207.15700.54



22207.12200.54



21392.04900.54



21392.06000.54

CODICE Code	MISURE Overall size	INTERASSE C.to C.
03050.09600	126x53	96
03050.06400	85x37	64
09239.05000	50x57	-
09239.04200	42x49	-
09239.03400	34x51	-
30710.03000	-	Ø 30

CODICE Code	MISURE Overall size	INTERASSE C.to C.
33726.0530N	24x87	N 53
33726.0420N	24x76	N 42
33726.0340N	24x68	N 34
33726.0240N	24x58	N 24

CODICE Code	MISURE Overall size	INTERASSE C.to C.
21392.04900	18x59	-
21392.06000	22x71	-
22207.15700	29x157	-
22207.12200	22x124	-

Luigi XVI

Serie realizzabile in tutte le finiture indicate a catalogo / Series available in all finishes in the catalogue.



Finitura / Finish: 09 - Florence



12212Z06000.09



12212Z05000.09



12212Z04000.07



45984Z04500.09



24222Z03000.09



30112Z02701.09



30112Z02700.09



24222Z02500.09

CODICE Code	MISURE Overall size	INTERASSE C.to C.
12212Z06000	-	Ø 60
12212Z05000	-	Ø 50
12212Z04000	-	Ø 40
24222Z03000	30x22	Ø 30
24222Z02500	25x20	Ø 25

CODICE Code	MISURE Overall size	INTERASSE C.to C.
30112Z02700	27x27x15	Ø 19
30112Z02701	27x27x15	Ø 19
45984Z04500	45x45	-

Luigi XVI

Serie realizzabile in tutte le finiture indicate a catalogo / Series available in all finishes in the catalogue.

Luigi XVI

Serie realizzabile in tutte le finiture indicate a catalogo / Series available in all finishes in the catalogue.



Finitura / Finish: 54 - Patinè bm

Finitura / Finish: 54 - Patinè bm



12238.06000.54



09238.05000.54



30703.04100.54



12235.05500.54



09236.05000.54



30642.035V0.54



30642.03500.54



12238.05000.54



09238.04200.54



33727.0420N.54



12235.04700.54



09236.04200.54



33729.0420N.54



12238.04000.54



09238.03400.54



12235.03700.54



09236.03400.54

CODICE Code	MISURE Overall size	INTERASSE C.to C.	CODICE Code	MISURE Overall size	INTERASSE C.to C.	CODICE Code	MISURE Overall size	INTERASSE C.to C.	CODICE Code	MISURE Overall size	INTERASSE C.to C.
09238.05000	50x67	-	30703.04100	-	Ø 41	09236.05000	50x57	-	30642.035V0	22x35	-
09238.04200	42x57	-	33727.0340N	27x61	N 34	09236.04200	42x49	-	30642.03500	35x22	-
09238.03400	38x48	-	33727.0240N	27x51	N 24	09236.03400	34x43	-	33729.0420N	22x76	N 42
12238.06000	-	Ø 60	33727.0420N	27x69	N 42	12235.05500	-	Ø 55	33729.0340N	22x68	N 34
12238.05000	-	Ø 50				12235.04700	-	Ø 47	33729.0240N	22x58	N 24
12238.04000	-	Ø 40				12235.03700	-	Ø 37			



Regency

Serie realizzabile in tutte le finiture indicate a catalogo / Series available in all finishes in the catalogue.

Regency

Serie realizzabile in tutte le finiture indicate a catalogo / Series available in all finishes in the catalogue.

Finitura / Finish: 54 - Patinè bm

Finitura / Finish: 54 - Patinè bm



03850.09600.54



03850.06400.54



06222.09200.54



06222.07200.54



21850.05700.54



30850.038V0.54



33850.0420N.54





24850Z03000.54



24850Z02500.54

CODICE Code	MISURE Overall size	INTERASSE C. to C.
03850.09600	122x67	96
03850.06400	83x55	64
06222.09200	92x49	32
06222.07200	72x38	32

CODICE Code	MISURE Overall size	INTERASSE C. to C.
21850.05700	22x68	-
24850Z03000	30x26	Ø 30
24850Z02500	25x23	Ø 25
30850.038V0	25x38	-
33850.0420N	31x76	N 42 
33850.0340N	31x68	N 34 

Cosmopolitan

DESIGN: MARELLA DESIGN LAB

Serie realizzabile in tutte le finiture indicate a catalogo / Series available in all finishes in the catalogue.

Ceramica / Ceramic: Bianca decoro vintage grigio / White deco vintage grey
Finitura / Finish: 25 - Argento vecchio / Old silver



15178P12815.25

24178P06915.25

Cosmopolitan

DESIGN: MARELLA DESIGN LAB

Serie realizzabile in tutte le finiture indicate a catalogo / Series available in all finishes in the catalogue.

Ceramica / Ceramic: Blu decoro Vintage Poland / Blu deco Vintage Poland
Finitura / Finish: 36 - Cromo lucido / Bright chrome



15178P12886.36

24178P06986.36

CODICE <i>Code</i>	MISURE <i>Overall size</i>	INTERASSE <i>C. to C.</i>
15178P12815.25	144x27x32	128
24178P06915.25	69x25x27	-

CODICE <i>Code</i>	MISURE <i>Overall size</i>	INTERASSE <i>C. to C.</i>
15178P12886.36	144x27x32	128
24178P06986.36	69x25x27	-



Grace

DESIGN: MARELLA DESIGN LAB

Serie realizzabile in tutte le finiture indicate a catalogo / Series available in all finishes in the catalogue.

C.415

Ceramica / Ceramic: Bianca lucida / Bright white
Finitura / Finish: 32- Nickel lucido / Bright nickel

Ceramica



15176P1281A.32



24176P0581A.32



24316P0351A.32

CODICE
Code

15176P1281A.32
24176P0581A.32
24316P0351A.32

MISURE
Overall size

161x32x34
58x32x29
34x29

INTERASSE
C.to C.

128
-
Ø 35



Ceramica / Ceramic: Panna / Cream
Finitura / Finish: 07- Oro di Valenza / Oro di Valenza



Ceramica / Ceramic: Nero lucido / Bright black
Finitura / Finish: 32- Nickel lucido / Bright nickel



Ceramica / Ceramic: Panna / Cream
Finitura / Finish: 46- Oro opaco / Mat gold



Ceramica / Ceramic: Panna / Cream
Finitura / Finish: 47- Argento orientale / Oriental silver



FINITURE E COMBINAZIONI
SULLA SERIE COMPLETA:
FINISHES AND COMBINATIONS AVAILABLE
ON THE COMPLETE RANGE:



CODICE
Code

15176P1282A.07
24176P0582A.07
24316P0352A.07

CODICE
Code

15176P128BA.32
24176P058BA.32
24316P035BA.32

CODICE
Code

15176P1282A.46
24176P0582A.46
24316P0352A.46

CODICE
Code

15176P1281A.47
24176P0581A.47
24316P0351A.47



Grace

DESIGN: MARELLA DESIGN LAB

Serie realizzabile in tutte le finiture indicate a catalogo / Series available in all finishes in the catalogue.

Ceramica / Ceramic: Nera - decoro carillon oro / Black - deco carillon gold
Finitura / Finish: 46- Oro opaco / Mat gold



15176P128EJ.46

24176P058EJ.46

24316P035EJ.46

Grace

DESIGN: MARELLA DESIGN LAB

Serie realizzabile in tutte le finiture indicate a catalogo / Series available in all finishes in the catalogue.

Ceramica / Ceramic: Panna - decoro armonia oro / Cream - deco armonia gold
Finitura / Finish: 07- Oro di Valenza



15176P12821.07

24176P05821.07

24316P03521.07

CODICE Code	MISURE Overall size	INTERASSE C.to C.
15176P128EJ.46	161x32x34	128
24176P058EJ.46	58x32x29	-
24316P035EJ.46	34x29	Ø 35

CODICE Code	MISURE Overall size	INTERASSE C.to C.
15176P12821.07	161x32x34	128
24176P05821.07	58x32x29	-
24316P03521.07	34x29	Ø 35

FINITURE E COMBINAZIONI DISPONIBILI SULLA SERIE COMPLETA:
FINISHES AND COMBINATIONS AVAILABLE ON THE COMPLETE RANGE:

C.420

Ceramica / Ceramic: Panna decoro carillon oro / Cream deco carillon gold
Finitura / Finish: 07- Oro di Valenza



deco carillon
deco carillon

CODICE
Code

15176P1282J.07
24176P0582J.07
24316P0352J.07



deco armonia
deco armonia

CODICE
Code

15176P12821.07
24176P05821.07
24316P03521.07

Ceramica / Ceramic: Bianca decoro carillon platino / White deco carillon platinum
Finitura / Finish: 19- Similferro / Similariron



deco carillon
deco carillon

CODICE
Code

15176P1281X.19
24176P0581X.19
24316P0351X.19



deco armonia
deco armonia

CODICE
Code

15176P12812.19
24176P05812.19
24316P03512.19

Ceramica / Ceramic: Bianca decoro carillon platino / White deco carillon platinum
Finitura / Finish: 32- Nickel lucido / Bright nickel



deco carillon
deco carillon

CODICE
Code

15176P1281X.32
24176P0581X.32
24316P0351X.32



deco armonia
deco armonia

CODICE
Code

15176P12812.32
24176P05812.32
24316P03512.32

FINITURE E COMBINAZIONI DISPONIBILI SULLA SERIE COMPLETA:
FINISHES AND COMBINATIONS AVAILABLE ON THE COMPLETE RANGE:

C.421

Ceramica / Ceramic: Nera opaca decoro carillon platino / Matt black deco carillon platinum
Finitura / Finish: 47- Argento orientale / Oriental silver



deco carillon
deco carillon

CODICE
Code

15176P128EX.47
24176P058EX.47
24316P035EX.47



deco armonia
deco armonia

CODICE
Code

15176P128E2.47
24176P058E2.47
24316P035E2.47

Ceramica / Ceramic: Panna decoro carillon oro / Cream deco carillon gold
Finitura / Finish: 46- Oro opaco / Mat gold



deco carillon
deco carillon

CODICE
Code

15176P1282J.46
24176P0582J.46
24316P0352J.46



deco armonia
deco armonia

CODICE
Code

15176P12821.46
24176P05821.46
24316P03521.46

Ceramica / Ceramic: Nero opaco decoro carillon oro / Matt black deco carillon gold
Finitura / Finish: 46- Oro opaco / Mat gold



deco carillon
deco carillon

CODICE
Code

15176P128EJ.46
24176P058EJ.46
24316P035EJ.46



deco armonia
deco armonia

CODICE
Code

15176P128E1.46
24176P058E1.46
24316P035E1.46

Ceramica



Simbologia / *Simbology*

Serie realizzabile in tutte le finiture indicate a catalogo / *Series available in all finishes in the catalogue.*

COMPOSIZIONE DEL CODICE ARTICOLO *ARTICLE CODE COMPOSITION*

Esempio / *Example:* 24136P0302B09

- 24 Codice Famiglia / *Family code*
- 136 Codice Modello / *Model code*
- P Materiale / *Material*
- 030 Diametro / *Diameter - Interasse / CtoC*
- 2 Colore ceramica / *Ceramic code*
- B Codice decoro / *Decoration code*
- 09 Finitura del metallo / *Metal finish*

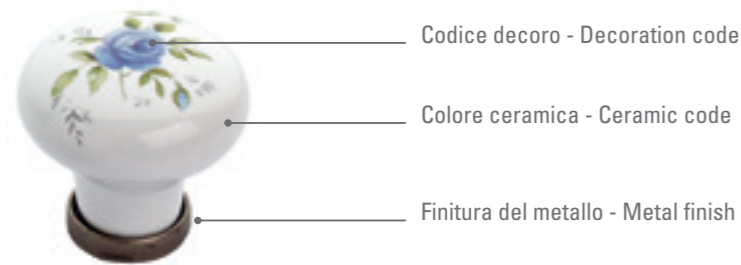

Ceramica / *Classic*



DESIGN: MARELLA DESIGN LAB

Serie realizzabile in tutte le finiture indicate a catalogo / *Series available in all finishes in the catalogue.*

Finitura / *Finish:* 19- Similferro / *Similiron*
1C Ceramica bianca / *Ceramic white*



CODICE <i>Code</i>	MISURE <i>Overall size</i>	INTERASSE <i>C. to C.</i>
15136P1281C.19	146x24	128
15136P0961C.19	112x22	96
24136P0301C.19	30x28	Ø 30
24136P0251C.19	25x24	Ø 25

Ceramica/Classic

DESIGN: MARELLA DESIGN LAB

Serie realizzabile in tutte le finiture indicate a catalogo / Series available in all finishes in the catalogue.

COMBINAZIONI DISPONIBILI: COMBINATION AVAILABLE:

Finitura / Finish: 1A.19 Bianco / White - Similferro / Similiron



Finitura / Finish: 1B.07 Panna / Cream - Oro di Valenza



Ceramica/Classic

DESIGN: MARELLA DESIGN LAB

Serie realizzabile in tutte le finiture indicate a catalogo / Series available in all finishes in the catalogue.

COMBINAZIONI DISPONIBILI: COMBINATION AVAILABLE:

Finitura / Finish: 1B.09 Bianco / White - Florence



Finitura / Finish: 1C.09 Bianco / White - Florence



Finitura / Finish: 1A.09 Bianco / White - Florence



Finitura / Finish: 3A.09 Champagne - Florence



Finitura / Finish: 2B.09 Panna / Cream - Florence



Finitura / Finish: 3F.09 Champagne - Florence



Finitura / Finish: 2A.09 Panna / Cream - Florence



Finitura / Finish: 3A.19 Champagne - Similferro / Similiron



Finitura / Finish: 1C.32 Bianco / White - Nickel lucido / Bright Nickel



Ceramica/Classic

DESIGN: MARELLA DESIGN LAB

Serie realizzabile in tutte le finiture indicate a catalogo / Series available in all finishes in the catalogue.

COMBINAZIONI DISPONIBILI: COMBINATION AVAILABLE:

Finitura / Finish: 2A.22 Panna / Cream - Old America



Finitura / Finish: 2H.09 Panna / Cream - Florence



Ceramica/Classic

DESIGN: MARELLA DESIGN LAB

Serie realizzabile in tutte le finiture indicate a catalogo / Series available in all finishes in the catalogue.

Ceramica / Ceramic: Bianca / White
Finitura / Finish: 09 - Florence



15141P0961A.09



24136P0251A.09



24136P0301A.09

CODICE Code

15141P0961A.09
24136P0301A.09
24136P0251A.09

MISURE Overall size

112x18
30x28
25x24

INTERASSE C. to C.

96
Ø 30
Ø 25

Ceramica/Classic

DESIGN: MARELLA DESIGN LAB

Serie realizzabile in tutte le finiture indicate a catalogo / Series available in all finishes in the catalogue.

COMBINAZIONI DISPONIBILI: COMBINATION AVAILABLE:

Finitura / Finish: 1A.09 Bianco / White - Florence



Finitura / Finish: 2A.09 Panna / Cream - Florence



Ceramica/Classic

DESIGN: MARELLA DESIGN LAB

Serie realizzabile in tutte le finiture indicate a catalogo / Series available in all finishes in the catalogue.

COMBINAZIONI DISPONIBILI: COMBINATION AVAILABLE:

Finitura / Finish: 2F.09 Panna / Cream - Florence



Finitura / Finish: 3A.09 Champagne - Florence



Finitura / Finish: 1A.19 Bianco / White - Similferro / Similiron



Finitura / Finish: 2B.09 Panna / Cream - Florence



Finitura / Finish: 2G.09 Panna / Cream - Florence



Finitura / Finish: 3F.07 Champagne - Oro di Valenza



Finitura / Finish: 1H.07 Bianco / White - Oro di Valenza



Finitura / Finish: 2D.09 Panna / Cream - Florence



Finitura / Finish: 2H.09 Panna / Cream - Florence



Maniglie a conchiglia / Cup pulls

Maniglie a conchiglia / Cup pulls

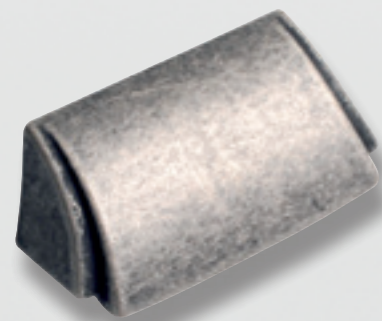

15046Z06900.25



15075Z11100.25

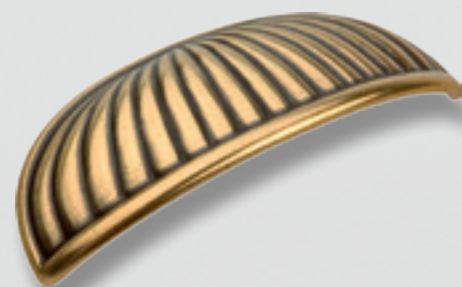

15067Z06400.07



15133Z09500.19



15100.08800.19



15133Z09500.22



15100.08800.09

CODICE Code	INTERASSE C. to C.	MISURE Overall size
15046Z06900	32	69x29
15075Z11100	96	111x40
15067Z06400	64	101x36

CODICE Code	INTERASSE C. to C.	MISURE Overall size
15133Z09500	64	96x52
15100.08800	32	91x47



Maniglie a conchiglia / Cup pulls

Maniglie a conchiglia / Cup pulls



15134Z10000L09



15144Z10000.09



15148Z10000.09



15134Z10000.09



15144Z10000.25



15147Z10000.09



15148Z10000.25



45144Z09000.09



15148Z10000.94

CODICE Code	INTERASSE C. to C.	MISURE Overall size
15134Z10000	64	102x34
15144Z10000	64	100x35
45144Z09000	-	90x27

- *L09 - L smalto champagne/Enamel champagne - 09 Florence
- *A09- A smalto bianco /Enamel White - 09 Florence
- *A32- A smalto bianco /Enamel White - 32 Nickel lucido/Bright nickel
- *A25- A smalto bianco /Enamel White - 25 Argento vecchio/ Old silver

CODICE Code	INTERASSE C. to C.	MISURE Overall size
15147Z10000	64	102x34
15148Z10000	64	102x34





21398.06200.07



21801Z05800.07



21397.05700.09



21396.05300.07



21396.04100.07



21008Z04900.07



21009Z04800.09



21395Z04900.03



21150.03800.07



37724.05000.54



37725.04500.54



22007Z12500.07



22006Z12500.07

CODICE Code	MISURE Overall size
21398.06200	22x73
21801Z05800	20x68
21397.05700	22x68
21396.05300	18x63
21396.04100	18x52

CODICE Code	MISURE Overall size
21008Z04900	21x59
21009Z04800	20x58
21395Z04900	20x59
21150.03800	37x52

CODICE Code	MISURE Overall size
37724.05000	33x59
37725.04500	31x57
22007Z12500	28x125
22006Z12500	28x125



CODICE Code	MISURE Overall size	Ø
24126Z03000	30x30	30
24177Z03000	30x21	30
24177Z03000	30x21	30
24134Z03000	30x21	30
24134Z03000	30x21	30
24446Z03000	30x22	30

VERSIONI CON SMALTO / VERSIONS WITH ENAMEL
 *L09 - L smalto champagne/Enamel champagne - 09 Florence
 *A09- A smalto bianco /Enamel White - 09 Florence
 *A32- A smalto bianco /Enamel White - 32 Nickel lucido/Bright nickel
 *A25- A smalto bianco /Enamel White - 25 Argento vecchio/ Old silver

CODICE Code	MISURE Overall size	Ø
24083Z03000	30x23	30
24083Z02500	25x21	25
24081Z03000	30x23	30
24081Z02500	25x21	25
24220Z03000	30x22	30
24220Z02500	25x20	25

CODICE Code	MISURE Overall size	Ø
24130Z03000	30x22	30
24130Z02500	25x20	25
24221Z03000	30x22	30
24221Z02500	25x20	25
24222Z03000	30x22	30
24222Z02500	25x20	25

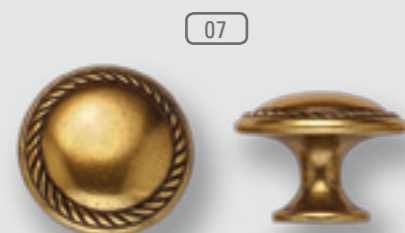

07

24223Z



19

24224Z

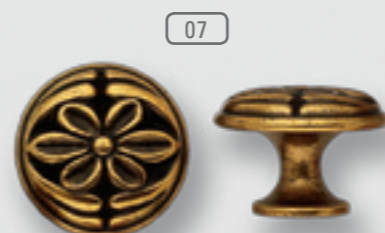

07

24802Z



07

24494Z



03

24408Z



07

24406Z



54

24286Z

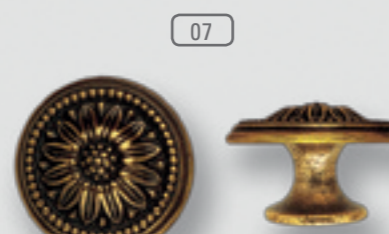

07

24225Z



09

24496Z

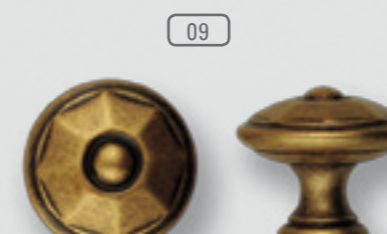

09

24403



03

24499Z



03

24499

CODICE Code	MISURE Overall size	Ø
24223Z03000	30x22	30
24223Z02500	25x20	25
24224Z03000	30x22	30
24224Z02500	25x20	25
24802Z03000	30x22	30
24802Z02500	25x20	25

CODICE Code	MISURE Overall size	Ø
24286Z03000	30x21	30
24286Z02500	25x19	25
24225Z03000	30x22	30
24225Z02500	25x20	25
24496Z03500	35x26	35
24496Z03000	30x24	30
24496Z02500	25x21	25

CODICE Code	MISURE Overall size	Ø
24494Z03500	35x26	35
24494Z03000	30x24	30
24494Z02500	25x21	25
24408Z03500	35x30	35
24408Z03000	30x26	30
24408Z02500	25x23	25
24406Z03500	35x26	35
24406Z03000	30x24	30
24406Z02500	25x21	25

CODICE Code	MISURE Overall size	Ø
24403.03501	35x29	35
24403.03001	30x26	30
24403.02501	25x22	25
24499Z03500	35x28	35
24499Z03000	30x24	30
24499Z02500	25x21	25
24499.04001	40x34	40

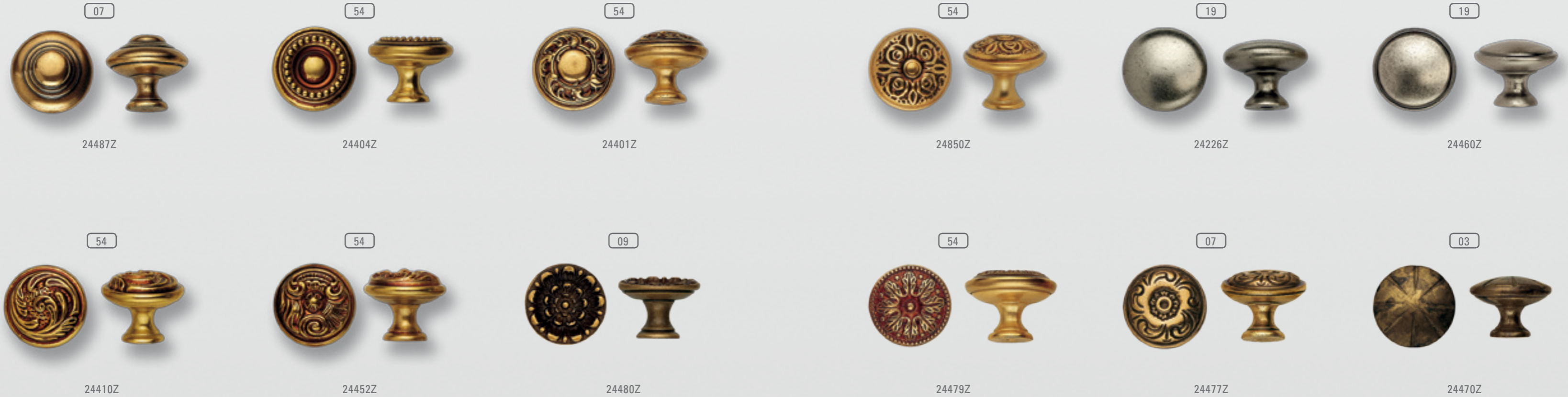

CODICE Code	MISURE Overall size	Ø
24487Z03500	35x31	35
24487Z03000	30x27	30
24487Z02500	25x25	25
24404Z03500	35x25	35
24404Z03000	30x23	30
24404Z02500	25x21	25
24401Z03500	35x29	35
24401Z03000	30x24	30
24401Z02500	25x23	25

CODICE Code	MISURE Overall size	Ø
24410Z03500	35x28	35
24410Z03000	30x24	30
24410Z02500	25x22	25
24452Z03500	35x28	35
24452Z03000	30x26	30
24452Z02500	25x23	25
24452Z02000	20x19	20
24480Z02500	25x17	25
24480Z03000	30x19	30
24480Z02000	20x15	20

CODICE Code	MISURE Overall size	Ø
24850Z03000	30x26	30
24850Z02500	25x23	25
24226Z03500	35x27	35
24226Z03000	30x24	30
24226Z02500	25x20	25
24460Z03500	35x24	35
24460Z03000	30x24	30
24460Z02500	25x20	25

CODICE Code	MISURE Overall size	Ø
24479Z03500	35x26	35
24479Z03000	30x23	30
24479Z02500	25x20	25
24479Z02000	20x18	20
24477Z03000	30x23	30
24477Z02500	25x20	25
24477Z02000	20x18	20
24470Z03000	30x23	30
24470Z02500	25x20	25
24470Z02000	20x18	20



09

24210Z



09

24316Z



19

24131Z



09

24216Z



03

24488Z



03

24111Z



03

24462Z



07

24260Z



03

24463Z

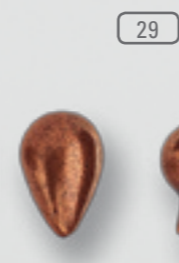

29

24507Z



29

24508Z



07

24264Z



CODICE Code	MISURE Overall size	Ø
24210Z03000	28x19	28
24316Z04000	40x24	40
24316Z03500	35x22	35
24316Z03000	30x20	30
24316Z02500	25x17	25

CODICE Code	MISURE Overall size	Ø
24131Z03200	32x27	32
24462Z04000	40x29x35	-
24260Z03000	31x25x18	-
24463Z03500	35x20x22	-

CODICE Code	MISURE Overall size	Ø
24216Z03000	29x20x20	-
24488Z04800	48x30x24	-
24488Z03700	37x23x21	-
24488Z03000	30x19x18	-
24111Z03500	35x24x23	-

CODICE Code	MISURE Overall size	Ø
24507Z02200	14x22x21	-
24508Z01900	14x19x21	-
24264Z04000	40x26	40
24264Z03000	30x24	30
24264Z02000	20x20	20



03

24471Z



41

24169Z



48

24165Z



36

24166Z



07

24213Z



34

24075Z



22

24231Z



07

24108Z

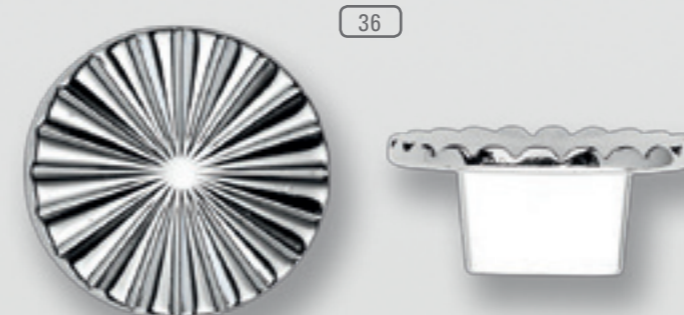

36

24157Z



32

24172Z

CODICE Code	MISURE Overall size	Ø
24471Z03800	38x31	38
24471Z03000	30x25	30
24169Z03000	30x30	30
24165Z03500	35x33x22	35

CODICE Code	MISURE Overall size	Ø
24075Z03800	34x25	38
24075Z03000	26x21	30
24231Z03200	30x32x29	-
24108Z04500	45x24	45
24108Z03000	30x20	30

CODICE Code	MISURE Overall size	Ø
24166Z04000	40x24	40
24213Z04500	45x45x22	-

CODICE Code	MISURE Overall size	Ø
24157Z03000	30x20	30
24157Z05000	50x50x22	int. 16
24157Z06900	69x69x24	int. 32
24172Z04700	47x37x24	-



CODICE Code	MISURE Overall size	Ø
24160Z03200	48x52x27	int. 32
24229Z02800	28x28x25	-
24159Z03400	34x33x27	-
24084Z04500	45x25x22	-

CODICE Code	MISURE Overall size	Ø
24037Z02400	24X18X19	-
24086Z03500	34x25x20	-
24085Z03500	35x21x21	-
24090Z04500	41x20x24	-

Pomoli/Knobs



19

24137Z



19

24073Z



09

24504Z



03

24568Z



19

24503Z



09

24089Z



09

24064Z03000



09

24064Z05200



CODICE
Code

24064Z03000
24064Z05200

MISURE
Overall size

30x30x27
52x52x27

Ø

-
int. 32

Versioni smaltate disponibili / Glazed versions available



X32 - Smalto/ Enamel:
Arancio-Rosso / Orange-Red
Finitura/ Finish: 32 Nickel Lucido/ Bright Nickel



Y32 Smalto/ Enamel
Giallo/ Verde - Yellow/Green
Finitura/Finish: 32 Nickel Lucido/Bright Nickel



K32 - Smalto/ Enamel:
Azzurro / Azzurro chiaro - Blue/Light blue
Finitura/Finish: 32 Nickel Lucido/Bright Nickel



W32 Smalto/ Enamel
Verde/ Arancio - Green/ Orange
Finitura/Finish: 32 Nickel Lucido/Bright Nickel



J32 Smalto/ Enamel
Rosa /Rosa chiaro- Pink /Light pink
Finitura/Finish: 32 Nickel Lucido/Bright Nickel

CODICE <i>Code</i>	MISURE <i>Overall size</i>	Ø
24137Z03900	39x25x23	-
24073Z02600	26x26x20	-
24504Z02600	26x26x20	-
24504Z02000	20x20x19	-
24568Z02500	25x25x28	-
24503Z02600	26x26x19	-
24089Z04500	45x23x22	-

Pomoli/Knobs

T.52

3A - Caiman Déco - Bordeaux



24064E0303A.32

24064E0523A.32

CODICE Code	MISURE Overall size	Ø
24064E0303A	30x30x27	-
24064E0523A	52x52x27	int. 32

Versioni Jungle disponibili / Jungle versions available



1A - Caiman Déco - Marrone chiaro /Light Brown
Finitura/Finish: 32 Nickel Lucido/Bright Nickel



5B - Crocodile Déco - Bianco/White
Finitura/Finish: 32 Nickel Lucido/Bright Nickel



2A - Caiman Déco - Marrone scuro/Dark Brown
Finitura/Finish: 32 Nickel Lucido/Bright Nickel



6B - Crocodile Déco - Amaranzo/Purple
Finitura/Finish: 32 Nickel Lucido/Bright Nickel



4A - Caiman Déco - Nero/Black
Finitura/Finish: 32 Nickel Lucido/Bright Nickel

T.53

Pomoli

Pomoli/Knobs



25

24256Z



09

24099Z



07



24179Z

19



24124Z



91



24162Z



07



24149Z



CODICE Code	MISURE Overall size	Ø
24256Z04900	49x46x28	-
24099Z04500	25x45x22	-
24179Z02000	20x17x24	-
24124Z02700	27x27x30	-

CODICE Code	MISURE Overall size	Ø
24162Z03200	32x15x28	int. 16
24149Z03500	35x35x22	-



36

24180Z



34

24181Z



36

24183Z



25

24087Z



07

24125Z



34

24387Z



34

24189Z



24501Z



09

24144Z



07

24109Z

CODICE Code	MISURE Overall size	Ø
24180Z0190M	19x19x22	-
24181Z0320M	32X30X25	-
24183Z0200M	20x26x35	-
24387Z0430M	43X21X30	-
24189Z0300M	30x11x25	-
24501Z02900	29x35	29
24501Z02500	25x30	25
24501Z02000	20x24	20

CODICE Code	MISURE Overall size	Ø
24087Z04500	45X21x24	-
24125Z04700	47x21x24	-
24144Z05000	50x23x19	-
24109Z04600	46x26x27	-



CODICE Code	MISURE Overall size	Ø
24134Z07300	73x31x23	int. 32
24147Z07300	73x31x23	int. 32
24250Z07300	73x31x24	int. 32

*L09 - L smalto champagne/Enamel champagne - 09 Florence
 *A09- A smalto bianco /Enamel White - 09 Florence
 *A32- A smalto bianco /Enamel White - 32 Nickel lucido/Bright nickel
 *A25- A smalto bianco /Enamel White - 25 Argento vecchio/ Old silver

CODICE Code	MISURE Overall size	Ø
24700Z06300	63x37x26	int. 32
24261Z07900	79x44x25	-
24261Z06400	64x36x25	-
24258Z09900	99x52x27	int. 32
24258Z07900	79x41x25	int. 32
24258Z06000	60x33x25	-

CODICE Code	MISURE Overall size	Ø
24177Z05800	58x32x26	-



CODICE Code	MISURE Overall size	Ø
24409.03000	30x24	30
24409.02500	25x20	25
24407.04500	45x23	45
24407.04000	40x23	40
24407.03500	35x20	35
24407.03000	30x19	30
24407.02500	25x17	25

CODICE Code	MISURE Overall size	Ø
24457.03000	30x24	30
24457.02500	25x21	25
24462.04000	40x29x35	-
24999.03000	30x25	30
24994.03000	30x30x22	-

Pomoli in Ceramica / Ceramic Knobs

Pomoli in Ceramica / Ceramic Knobs **PAGI**

T.62

T.63

Pomoli

Pomoli

Composizione del Codice Articolo / Article Code composition

24	136	P	030	2	B	09
----	-----	---	-----	---	---	----

24	Codice Famiglia - Family code
136	Codice Modello - Model code
P	Materiale - Material
030	Diametro - Diameter / Interasse - CtoC
2	Colore ceramica - Ceramic code
B	Codice decoro - Decoration code
09	Finitura del metallo - Metal finish



Codice decoro - Decoration code

Colore ceramica - Ceramic code

Finitura del metallo - Metal finish

Ceramica / Ceramic: 1 - Bianca / White

Ceramica / Ceramic: 2 - Panna / Cream

Ceramica / Ceramic: 3 - Champagne



CODICE Code	Ø	MISURE Overall size	COD. CERAMICA Ceramic Code	FINITURE finishes	COD. CERAMICA Ceramic Code	FINITURE finishes
24136P0301A	30	30x28	24136P0302A	07-09-22-25	24136P0303A	07
24136P0251A	25	25x24	24136P0252A		24136P0253A	

Combinazioni disponibili / Combination available



COD. CERAMICA Ceramic Code	FINITURE finishes
24136P0301B 24136P0251B	09



COD. CERAMICA Ceramic Code	FINITURE finishes
24136P0302B 24136P0252B	09



COD. CERAMICA Ceramic Code	FINITURE finishes
24136P0301C 24136P0251C	09-19-32



COD. CERAMICA Ceramic Code	FINITURE finishes
24136P0302D 24136P0252D	09



COD. CERAMICA Ceramic Code	FINITURE finishes
24136P0301H 24136P0251H	07



Pomoli in Ceramica / Ceramic Knobs

Pomoli in Ceramica / Ceramic Knobs



CODICE Code	Ø	MISURE Overall size
24178P069B4.07	-	69x25x27



COD. CERAMICA Ceramic Code	FINITURE finishes
24136P0302F 24136P0252F	09



COD. CERAMICA Ceramic Code	FINITURE finishes
24136P0303F 24136P0253F	07-09-22-25



COD. CERAMICA Ceramic Code	FINITURE finishes
24136P0302G 24136P0252G	09



COD. CERAMICA Ceramic Code	FINITURE finishes
24136P0302H 24136P0252H	09



CODICE Code
24178P0691A.36



CODICE Code
24178P06986.36



CODICE Code
24178P069BA.36



CODICE Code
24178P069F7.36



CODICE Code
24178P06923.07



CODICE Code
24178P06915.25



CODICE Code
24178P06924.07



Pomoli in Ceramica/Ceramic Knobs

Pomoli in Ceramica/Ceramic Knobs **PAGI**



CODICE Code	Ø	MISURE Overall size
24176P0581A.32	-	58x32x29



CODICE
Code
24176P0582A.07
24176P0352A.07



CODICE
Code
24176P0582A.46
24176P0352A.46



CODICE
Code
24176P058BA.32
24176P035BA.32



CODICE
Code
24176P0581A.47
24176P0351A.47



CODICE
Code
24176P0582J.07
24176P0352J.07



CODICE
Code
24176P0582I.07
24176P0352I.07



CODICE
Code
24176P0581X.19
24176P0351X.19



CODICE
Code
24176P05812.19
24176P03512.19



CODICE
Code
24176P0581X.32
24176P0351X.32



CODICE
Code
24176P05812.32
24176P03512.32



CODICE
Code
24176P058EX.47
24176P035EX.47



CODICE
Code
24176P058E2.47
24176P035E2.47



CODICE
Code
24176P0582J.46
24316P0352J.46



CODICE
Code
24176P0582I.46
24316P0352I.46



CODICE
Code
24176P058EJ.46
24176P035EJ.46



CODICE
Code
24176P058E1.46
24176P035E1.46

Pomoli in Ceramica / Ceramic Knobs

Pomoli in Ceramica / Ceramic Knobs



CODICE Code	Ø	MISURE Overall size
24316P0401A.47	40	39x33
24316P0351A.47	35	34x29

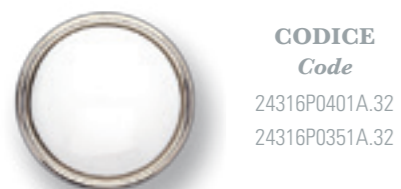

CODICE
Code
24316P0401A.32
24316P0351A.32



CODICE
Code
24316P0402A.46
24316P0352A.46



CODICE
Code
24316P040AA.19
24316P035AA.19



CODICE
Code
24316P040BA.32
24316P035BA.32



CODICE
Code
24316P0402A.82
24316P0352A.82



CODICE
Code
24316P040EA.32
24316P035EA.32



CODICE
Code
24316P0402A.32
24316P0352A.32



CODICE
Code
24316P0402A.83
24316P0352A.83



CODICE
Code
24316P040BA.83
24316P035BA.83



CODICE
Code
24316P0402A.07
24316P0352A.07



CODICE
Code
24316P040DA.19
24316P035DA.19



CODICE
Code
24316P040BS.32
24316P035BS.32



CODICE
Code
24316P040BW.46
24316P035BW.46



CODICE
Code
24316P040BW.07
24316P035BW.07



CODICE
Code
24316P040BW.15
24316P035BW.15



CODICE
Code
24316P040BZ.32
24316P035BZ.32



CODICE
Code
24316P0402V.76
24316P0352V.76



CODICE
Code
24316P040AU.22
24316P035AU.22



CODICE
Code
24316P040CA.09
24316P035CA.09



CODICE
Code
24316P040CA.22
24316P035CA.22



CODICE
Code
24316P040CA.76
24316P035CA.76



CODICE
Code
24316P040ET.07
24316P035ET.07



CODICE
Code
24316P040DT.07
24316P035DT.07



CODICE
Code
24316P040DT.46
24316P035DT.46



CODICE
Code
24316P040ES.25
24316P035ES.25



CODICE
Code
24316P040ES.47
24316P035ES.47



CODICE
Code
24316P040EW.46
24316P035EW.46



CODICE
Code
24316P040EY.47
24316P035EY.47



CODICE
Code
24316P040EY.25
24316P035EY.25





30643.038V0.54



30643.03800.54



30703.04100.54



30711.040V0.54



30710.03000.54



30709.06000.54



30116.045V0.54



30607.05000.54



30642.035V0.54



30642.03500.54



30733Z037V0.07



30850.038V0.54



30730Z050V0.07



30632.03900.54



30713.05400.54



30645.048V0.54

CODICE Code	MISURE Overall size
30643.038V0	25x38
30643.03800	38x25
30703.04100	Ø 41
30711.040V0	32x40
30710.03000	Ø 30

CODICE Code	MISURE Overall size
30642.035V0	22x35
30642.03500	35x22
30733Z037V0	25x37
30850.038V0	25x38
30730Z050V0	29x51

CODICE Code	MISURE Overall size
30709.06000	60x44
30116.045V0	43x45
30607.05000	50x43
30632.03900	39x39
30713.05400	54x35
30645.048V0	34x48

Portabiti/Hooks

Battenti/Knockers

T.148

T.149

Portabiti e battenti

Portabiti e battenti



43007.10600.03



43005.20500.11



26027.19000.07

CODICE <i>Code</i>	MISURE <i>Overall size</i>
43007.10600	75x106
43005.20500	75x205

CODICE <i>Code</i>	MISURE <i>Overall size</i>
26027.19000	109x190





45262.06500.54



45262.04700.54



45262.03900.54



45245.11000.54



45245.08000.54



45245.06700.54



CODICE Code	Ø	MISURE Overall size
45262.06500	Ø 65	-
45262.04700	Ø 47	-
45262.03900	Ø 39	-
45245.11000	-	62x110
45245.08000	-	45x80
45245.06700	-	38x67



54

11

03

45230.05000.11 45230.04300.11 45230.03500.11 45230.02800.11 45230.02300.11



45244.07000.54

45244.08800.54

45244

45230

CODICE Code	Ø
45230.05000	Ø 50
45230.04300	Ø 43
45230.03500	Ø 35
45230.02800	Ø 28
45230.02300	Ø 23

CODICE Code	MISURE Overall size
45244.07000	33x70
45244.08800	42x88

45249.10800.54



45249.07500.54



45249.05800.54



03

54

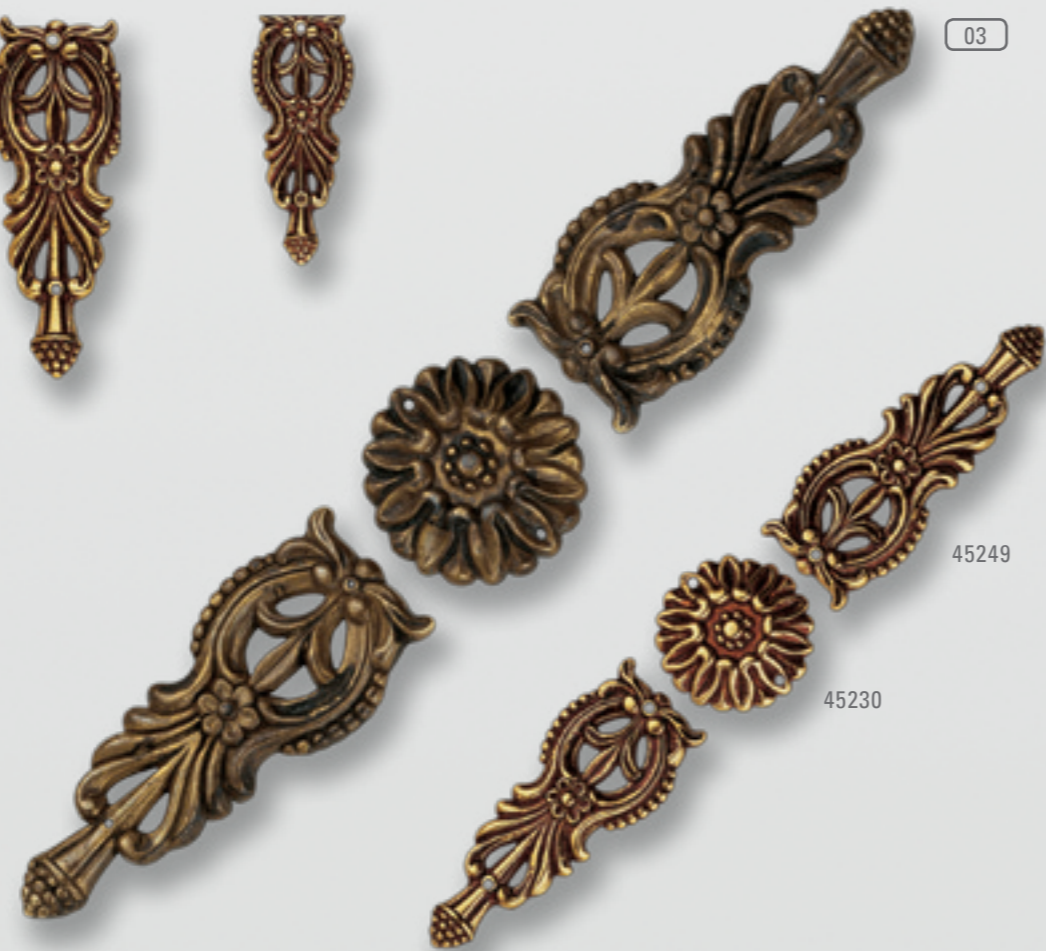

45249

45230

45230



45243.07300.54



45243.06000.54



CODICE Code	MISURE Overall size
45249.10800	43x108
45249.07500	29x75
45249.05800	23x58

CODICE Code	MISURE Overall size
45243.07300	45x73
45243.06000	38x60



45240.31800.54



45240.21800.54



45257.18000.54



45242.10500.54



45234.19100.54



07

45230

CODICE Code	MISURE Overall size
45240.31800	318x96
45240.21800	218x67

CODICE Code	MISURE Overall size
45257.18000	42x180
45242.10500	25x105
45234.19100	191x43



45983.07500.54



45982.05800.54



45983.06000.54



45982.04600.54



45248.09000.54



45248.06900.54



45248.05000.54



45264.15500.54



45990.10300.54



45266.06600.54

CODICE Code	MISURE Overall size
45983.07500	46x75
45983.06000	37x60
45982.05800	58x26
45982.04600	46x21

CODICE Code	MISURE Overall size
45248.09000	43x90
45248.06900	33x69
45248.05000	24x50

CODICE Code	MISURE Overall size
45264.15500	155x57
45990.10300	103x72
45266.06600	42x66



Barocco

PAGITM

T.193

Finitura/Finish: 25 - Argento vecchio / Old silver



**REGGIMENSOLA REGOLABILE /
ADJUSTABLE SHELF BRACKET**

Reggimensola

**CODICE
CODE**
42430Z12500

**MISURE
OVERALL SIZE**
125X77 mm





Glam

DESIGN: GEORG SEEBACHER

Serie realizzabile in tutte le finiture indicate a catalogo / Series available in all finishes in the catalogue.

Glam

DESIGN: GEORG SEEBACHER

Serie realizzabile in tutte le finiture indicate a catalogo / Series available in all finishes in the catalogue.

PAGI™

Finitura / Finish: 15 - Bagno oro / Gold plated



24274Z06600.15



24274Z04200.15



Finitura / Finish: 78 - Bagno Argento / Silver plated



24274Z06600.78



24274Z04200.78



CODICE Code	MISURE Overall size	INTERASSE C. to C.
24274Z06600	47x66x30	-
24274Z04200	30x42x24	-

CODICE Code	MISURE Overall size	INTERASSE C. to C.
24274Z06600	47x66x30	-
24274Z04200	30x42x24	-



Twist

COMBINAZIONI DISPONIBILI: COMBINATION AVAILABLE:

PAGTM

theme 02

"In questo concept, gli aspetti sensoriali e l'approccio di lasciare che ogni singolo pomolo sia slegato dal suo orientamento, sono le caratteristiche principali nello studio della serie Twist.

La stratificazione, la ripetizione di forme che si fondono e la libertà di montaggio hanno portato alla forma di un pomolo, che dà ai cristalli Swarovski una straordinaria inquadratura architettonica e scultorea. L'idea è nata dalla volontà di creare una forma in grado di elevare le superfici irregolari e che appare diversa, ogni qualvolta si cambia leggermente direzione di montaggio: Twist Unicità e imperfezione."

Nella collezione Twist, i cristalli Swarovski vengono proposti in tre differenti colorazioni: nero, abbinato al pomolo nero opaco dal carattere progressive e di tendenza; golden shadow abbinato al pomolo con finitura oro opaco per una versione più raffinata fashion, dalle tonalità brillanti; infine il cristallo Swarovski trasparente per magiche combinazioni e brillanti giochi di luce.

"The sensory aspects and the approach of letting each knob look individual by orientation, are the main features in the study of the Twist collection. The layering, repetition of shapes that blend and freedom of assembly led to the form of a knob, which gives the Crystals from Swarovski an extraordinary architectural and sculptural framing.

The idea was born from the desire to create a form that looks and seems to be different every time you change direction of mounting able to elevate the irregular surfaces: Uniqueness and imperfection."

The TWIST collection is presented with Crystals from Swarovski in three different colors: Black, combined with the knob in Matt black finish, a progressive and trendy version; golden shadow combined with the knob in gold finish for a more refined and fashion solution, with bright shades; finally the Crystals from Swarovski transparent for magic and brilliant version: exclusive and sparkling Made in Italy Knobs.



04 cristallo Swarovski Nero con finitura N2 nero Opaco

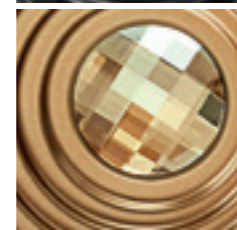

04 Crystals from Swarovski Black with finish N2 - Mat black



05 cristallo Swarovski Golden Shadow con finitura 46 Oro opaco

05 Crystals from Swarovski Golden shadow with finish 46 Mat gold

00 cristallo Swarovski trasparente con finiture: F5 Bianco Opaco/ 36 cromo lucido / 83 Graphite

00 Crystals from Swarovski Trasparent with finishes: F5 Mat white / 36 Bright chrome / 83 Graphite

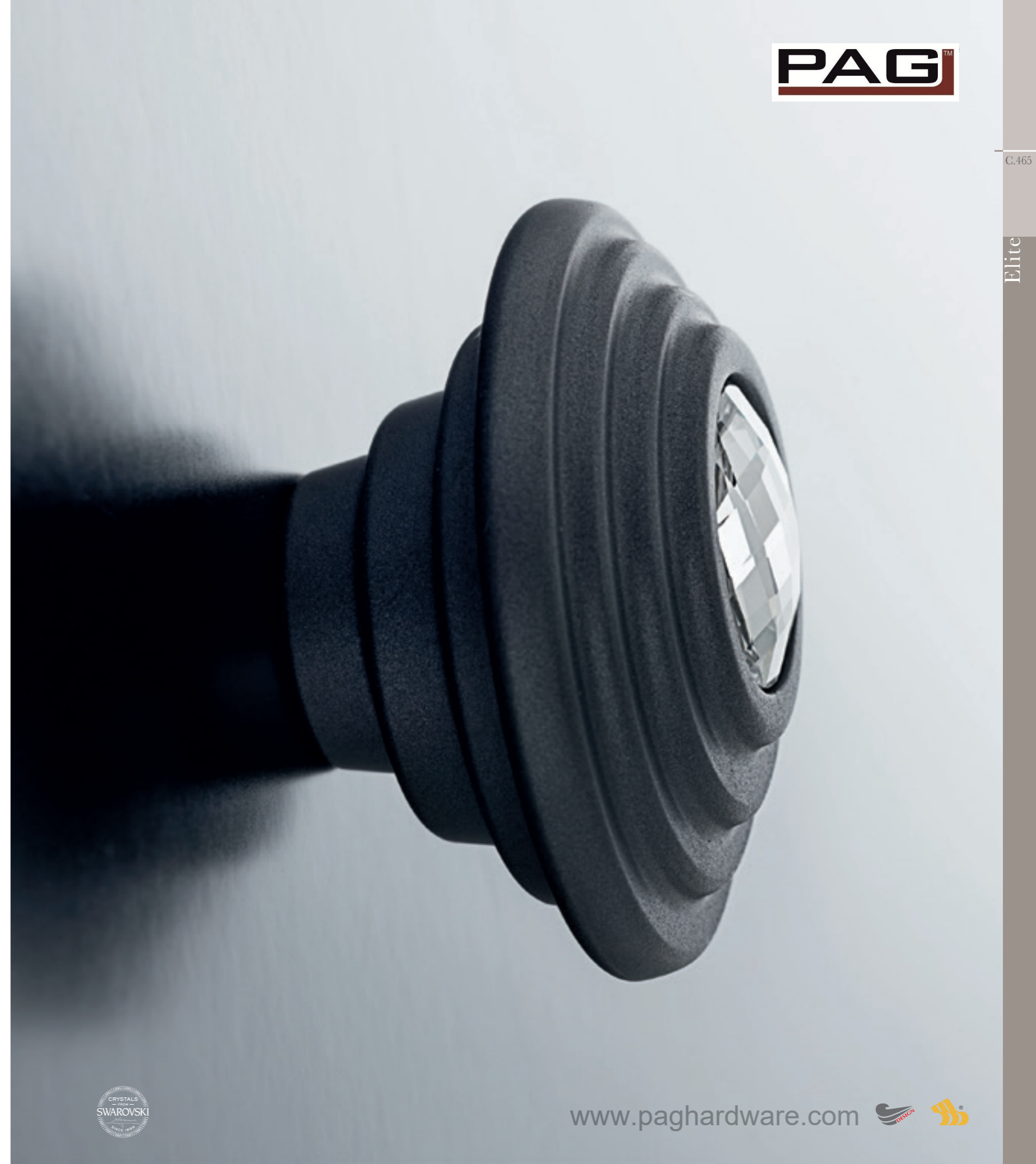
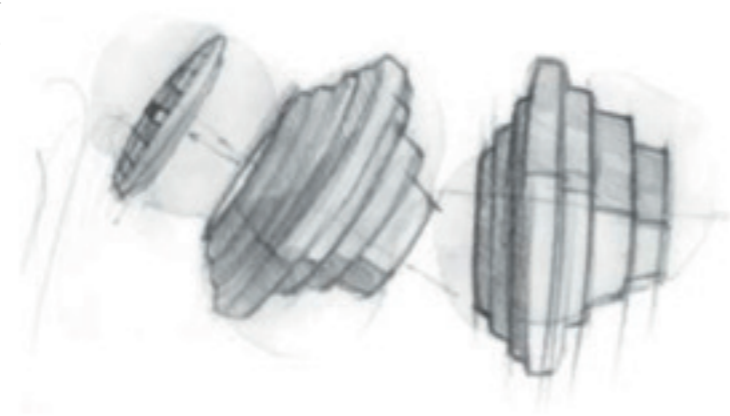

Twist

DESIGN: GEORG SEEBACHER

Serie realizzabile in tutte le finiture indicate a catalogo / Series available in all finishes in the catalogue.

F5 Bianco opaco / Mat white + 00 trasparente / Transparent Crystals from Swarovski



24273Z07200.F5



24273Z05200.F5



24273Z03200.F5



Twist

DESIGN: GEORG SEEBACHER

Serie realizzabile in tutte le finiture indicate a catalogo / Series available in all finishes in the catalogue.

46 Oro opaco / Mat gold + 05 Golden shadow Crystals from Swarovski



24273Z07205.46



24273Z05205.46



24273Z03205.46



CODICE <i>Code</i>	MISURE <i>Overall size</i>	INTERASSE <i>C. to C.</i>
24273Z07200.F5	72x36	Ø 72
24273Z05200.F5	52x33	Ø 52
24273Z03200.F5	32x26	Ø 32

CODICE <i>Code</i>	MISURE <i>Overall size</i>	INTERASSE <i>C. to C.</i>
24273Z07205.46	72x36	Ø 72
24273Z05205.46	52x33	Ø 52
24273Z03205.46	32x26	Ø 32

Twist

DESIGN: GEORG SEEBACHER

Serie eseguibile in tutte le finiture indicate a catalogo / Series available in all finishes in the catalogue.

C.469

N2 Nero opaco / Mat black + 04 Crystals from Swarovski

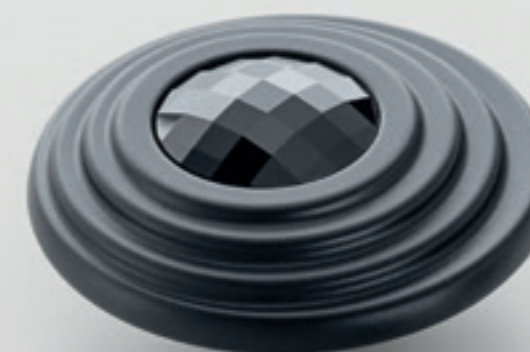

24273Z07204.N2



24273Z05204.N2



24273Z03204.N2



CODICE <i>Code</i>	MISURE <i>Overall size</i>	INTERASSE <i>C. to C.</i>
24273Z07204.N2	72x36	Ø 72
24273Z05204.N2	52x33	Ø 52
24273Z03204.N2	32x26	Ø 32



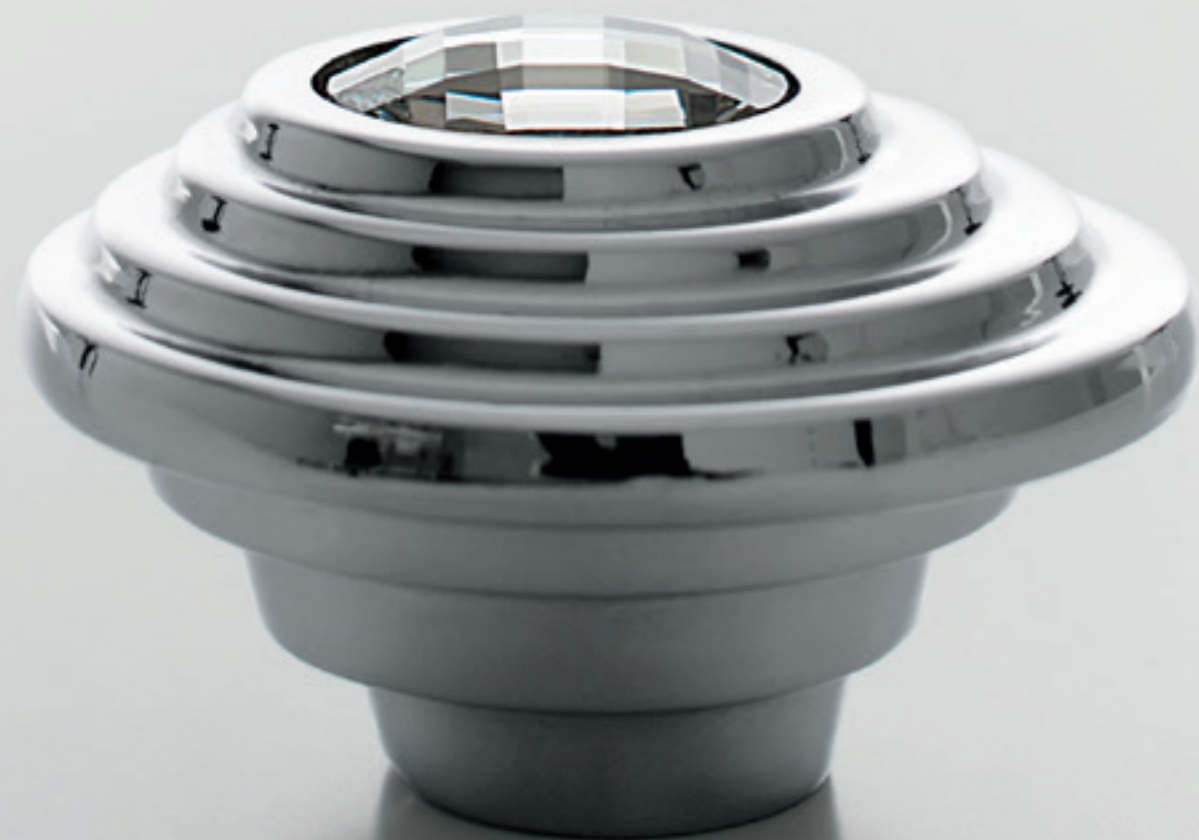

PAG



Cristallo trasparente disponibile con finiture /
Transparent crystal available with finishes:

- 36 - Cromo lucido / Bright chrome
- 83 - Graphite
- F5 - Bianco opaco / Mat white



Trend natura

theme 03

Introduction:

Jolie ed Amelie, eleganti maniglie impreziosite da cristalli Swarovski, caratterizzate da movimenti e geometrie semplici ma al contempo raffinate, in grado di celebrare linee e dettagli unici, presenti in natura. Amelie and Jolie, elegant and refined handles, embellished with Crystals from Swarovski, characterized by natural movements and geometries, at the same time refined, able to inspire unique details of nature.

Ispiration:

L'ispirazione nasce dal mondo della natura per imitarne le forme e creare oggetti di design molto affascinanti e di sicuro impatto emotivo. Questa collezione coglie l'essenza di morbidi ed eleganti movimenti naturali di foglie e fiori, trasformandoli in prodotti speciali; questa nuova gamma rappresenta un ottimo esempio di come la natura riesce ad ispirare particolari oggetti di design.

The inspiration comes from the natural world, the idea is to reproduce its forms creating objects having an attractive and emotional design.

This collection captures the essence of soft and elegant movements of natural leaves and flowers, turning them into special products; the ability of design makes the nature join special objects of design.

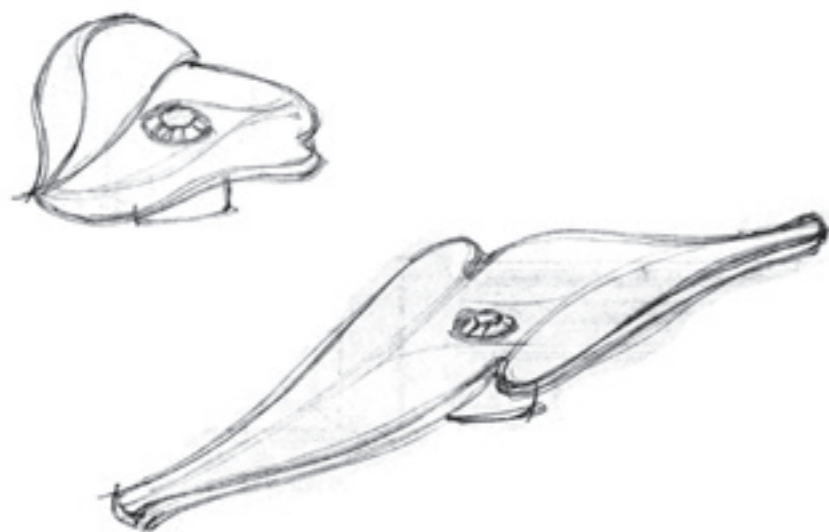

Amelie

DESIGN: MARELLA DESIGN LAB

Serie realizzabile in tutte le finiture indicate a catalogo / Series available in all finishes in the catalogue.

C.475

Finitura / Finish: 48 - Canna di fucile



15259Z17000.48



24259Z06000.48



24259Z03700.48



CODICE <i>Code</i>	MISURE <i>Overall size</i>	INTERASSE <i>C. to C.</i>
15259Z17000	170x48x23	-
24259Z06000	59x59x23	-
24259Z03700	37x36x20	-

15200

DESIGN: MARELLA DESIGN LAB

Serie realizzabile in tutte le finiture indicate a catalogo / Series available in all finishes in the catalogue.

C.481

Finitura / Finish: 32 - Nickel lucido / Bright Nickel



15200Z12800.32

15200Z09600.32

15200Z06400.32

24200Z02600.32

24200Z01500.32

24200Z02700.32

24200Z05200.32



CODICE <i>Code</i>	MISURE <i>Overall size</i>	INTERASSE <i>C.to C.</i>	CODICE <i>Code</i>	MISURE <i>Overall size</i>	INTERASSE <i>C.to C.</i>
15200Z12800	173x15x21	128	24200Z02700	27x27x21	-
15200Z09600	136x15x21	96	24200Z02600	27x15x21	-
15200Z06400	100x15x21	64	24200Z01500	15x15x21	-
24200Z05200	52x52x21	32			



15202

DESIGN: MARELLA DESIGN LAB

Serie realizzabile in tutte le finiture indicate a catalogo / Series available in all finishes in the catalogue.

C.485

Finitura / Finish: 32 - Nickel lucido / Bright Nickel

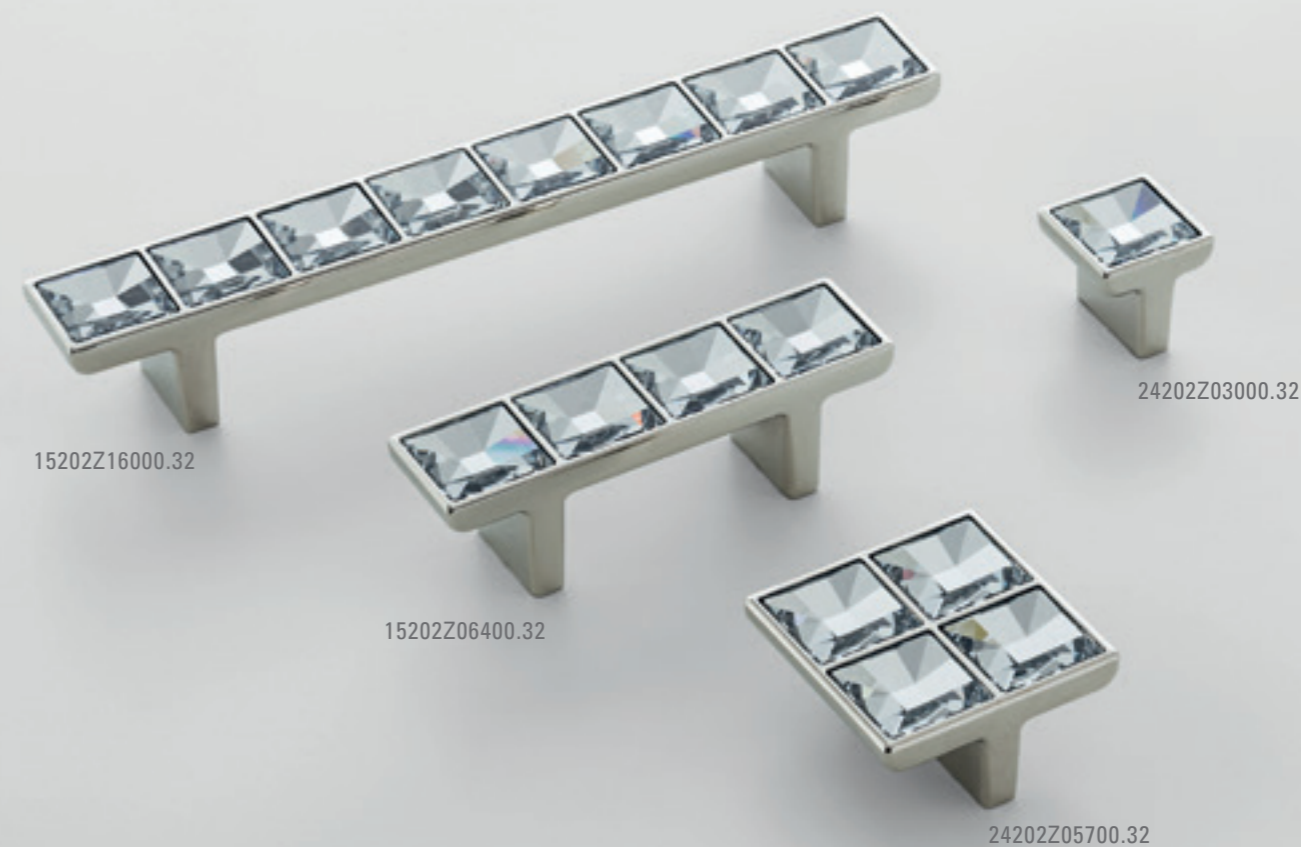

Elite



CODICE <i>Code</i>	MISURE <i>Overall size</i>	INTERASSE <i>C. to C.</i>
15202Z16000	219x30x34	160
15202Z06400	111x30x34	64
24202Z05700	57x57x29	32
24202Z03000	30x30x29	-

Madreperla / Mother of Pearl

DESIGN: MARELLA DESIGN LAB

Serie realizzabile in tutte le finiture indicate a catalogo / Series available in all finishes in the catalogue.

Madreperla / Mother of Pearl

DESIGN: MARELLA DESIGN LAB

Serie realizzabile in tutte le finiture indicate a catalogo / Series available in all finishes in the catalogue.

PAGITM

Finitura / Finish: 32 - Nickel lucido / Bright Nickel

Finitura / Finish: 32 - Nickel lucido / Bright Nickel

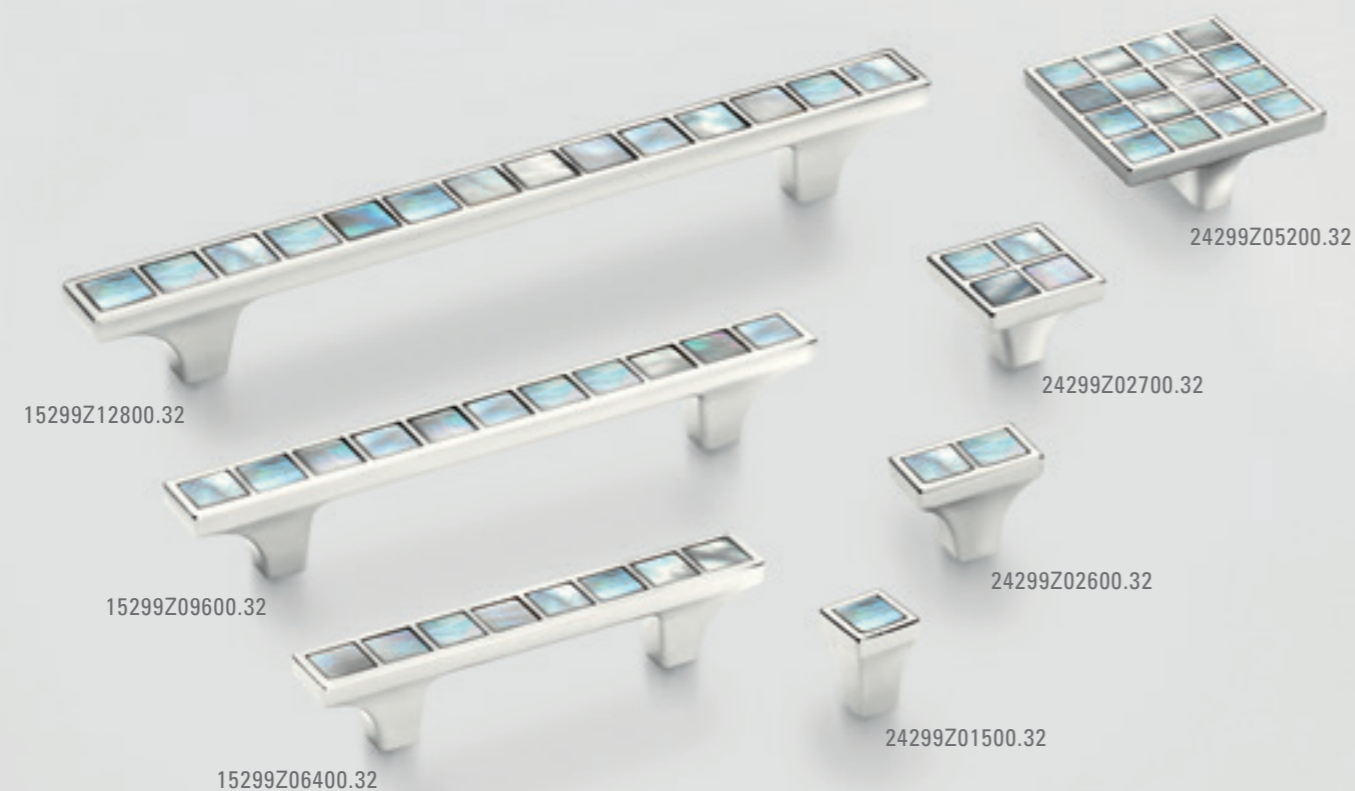

CODICE <i>Code</i>	MISURE <i>Overall size</i>	INTERASSE <i>C. to C.</i>
15299Z12800	173x15x21	128
15299Z09600	136x15x21	96
15299Z06400	100x15x21	64
24299Z05200	52x52x21	32

CODICE <i>Code</i>	MISURE <i>Overall size</i>	INTERASSE <i>C. to C.</i>
24299Z02700	27x27x21	-
24299Z02600	27x15x21	-
24299Z01500	15x15x21	-

CODICE <i>Code</i>	MISURE <i>Overall size</i>	INTERASSE <i>C. to C.</i>
15302Z16000	219x30x34	160
15302Z06400	111x30x34	64
24302Z05700	57x57x29	32
24302Z03000	30x30x29	-

SINTESI

DESIGN: MARCO BORTOLIN

Serie realizzabile in tutte le finiture indicate a catalogo / Series available in all finishes in the catalogue.

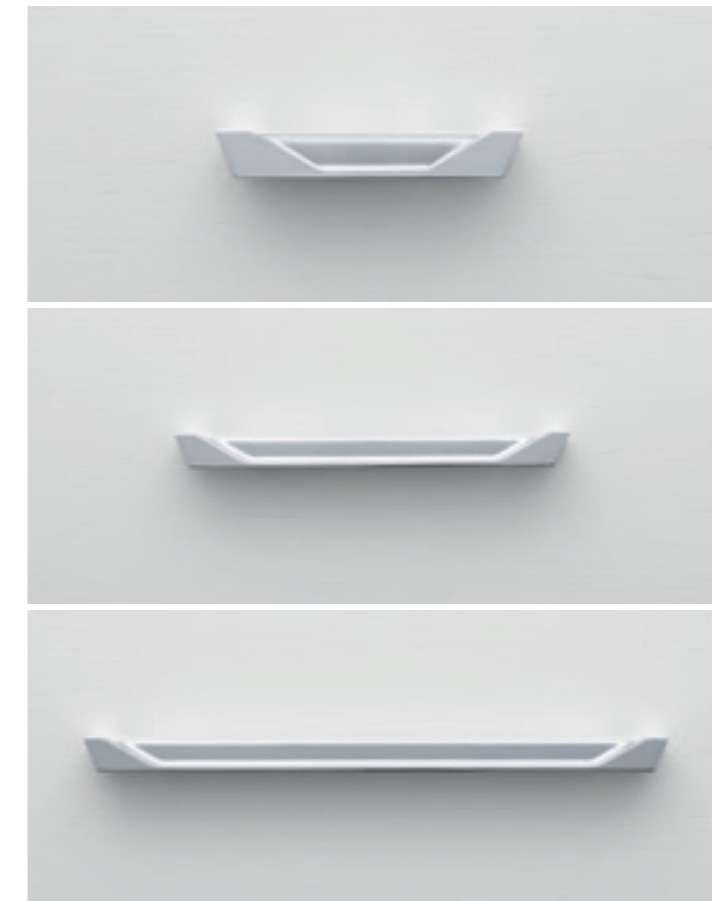

15188Z0320M

L. 110 W. 21 H. 18
 A 32
 C 14,5
 D 90
 E 16,5

15188Z1280M

L. 200 W. 20 H. 18
 A 128
 C 14,5
 D 180
 E 16,5

15188Z2240M

L. 295 W. 20 H. 18
 A 112
 C 14,5
 D 275
 E 16,5

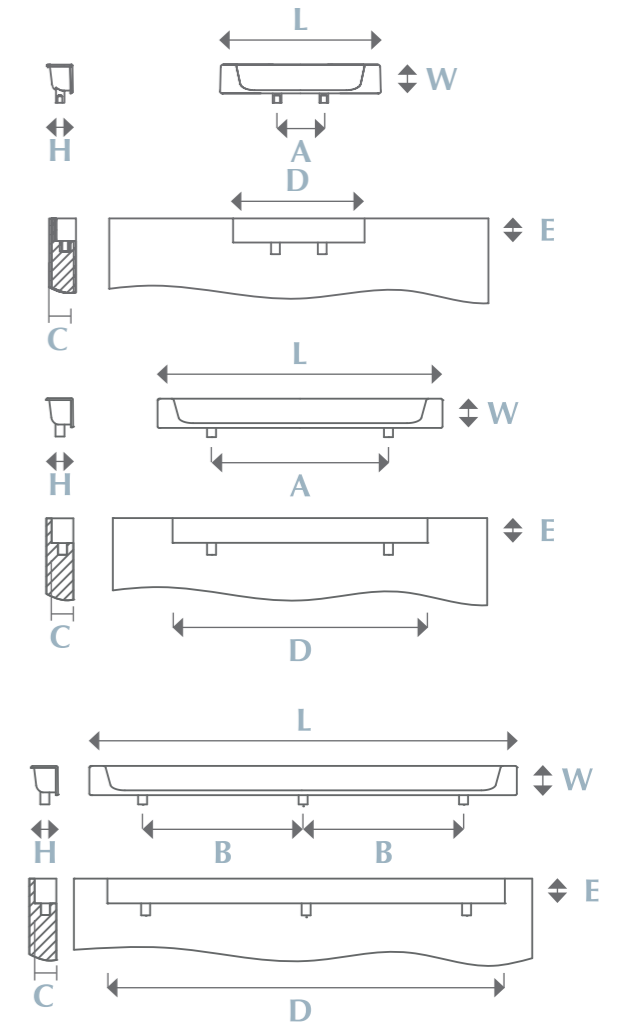

Disponibile disegni tecnici per l'incasso / Technical drawings available for the recession
 Per spessori a partire da 18 mm / For thickness above 18 mm

Finiture illustrate/ Illustrated finishes:
 45 CROMO OPACO/ MAT CHROME

Materiale/Material: ZAMA - ZAMAK

Maniglie realizzabili nelle finiture illustrate a fine catalogo.
 Handles available in the finishes presented at the end of the catalogue.



M.54



PAGTM

M.55



ONDA

DESIGN: MARCO BORTOLIN



Serie realizzabile in tutte le finiture indicate a catalogo / Series available in all finishes in the catalogue.

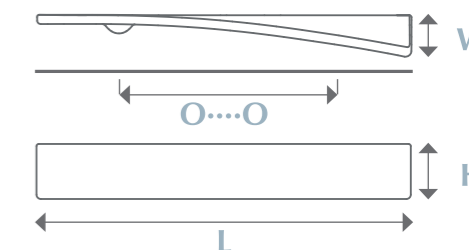

SX · L

DX · R



15182Z064DM - DESTRA/RIGHT
15182Z064SM - SINISTRA/LEFT

L. 110 W. 19 H. 25
O...O 64



15182Z096DM - DESTRA/RIGHT
15182Z096SM - SINISTRA/LEFT

L. 170 W. 19 H. 25
O...O 96



15182Z160DM - DESTRA/RIGHT
15182Z160SM - SINISTRA/LEFT

L. 250 W. 19 H. 25
O...O 160

Finiture illustrate/ Illustrated finishes:
34 NICKEL SATINATO / SATIN NICKEL INOX ASPECT
36 CROMO LUCIDO / BRIGHT CHROME

Materiale/Material: ZAMA - ZAMAK

Maniglie realizzabili nelle finiture illustrate a fine catalogo.
Handles available in the finishes presented at the end of the catalogue.

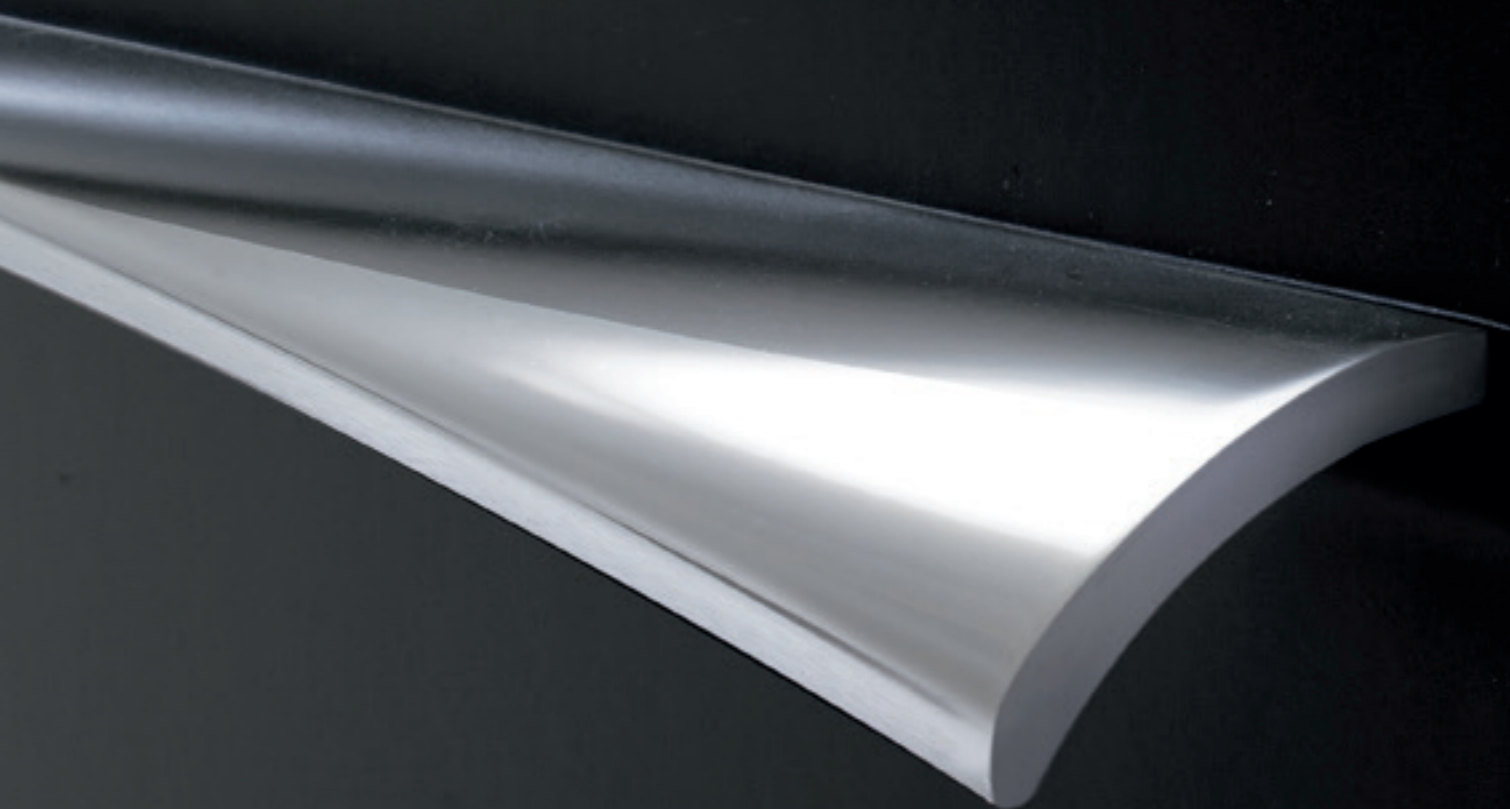

M.64



M.65



MUSA

DESIGN: MARCO BORTOLIN



Serie realizzabile in tutte le finiture indicate a catalogo / Series available in all finishes in the catalogue.

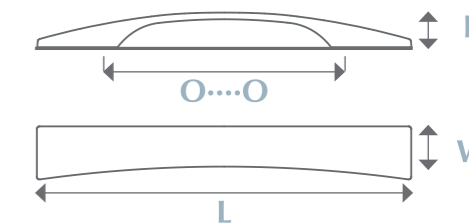

15185Z1280M

L. 210 W. 30 H. 19
O...O 128



15185Z1600M

L. 247 W. 30 H. 19
O...O 160

Finiture illustrate/ Illustrated finishes:
34 NICKEL SATINATO / SATIN NICKEL INOX ASPECT
36 CROMO LUCIDO / BRIGHT CHROME

Materiale/Material: ZAMA - ZAMAK

Maniglie realizzabili nelle finiture illustrate a fine catalogo.
Handles available in the finishes presented at the end of the catalogue.





M.110



M.111

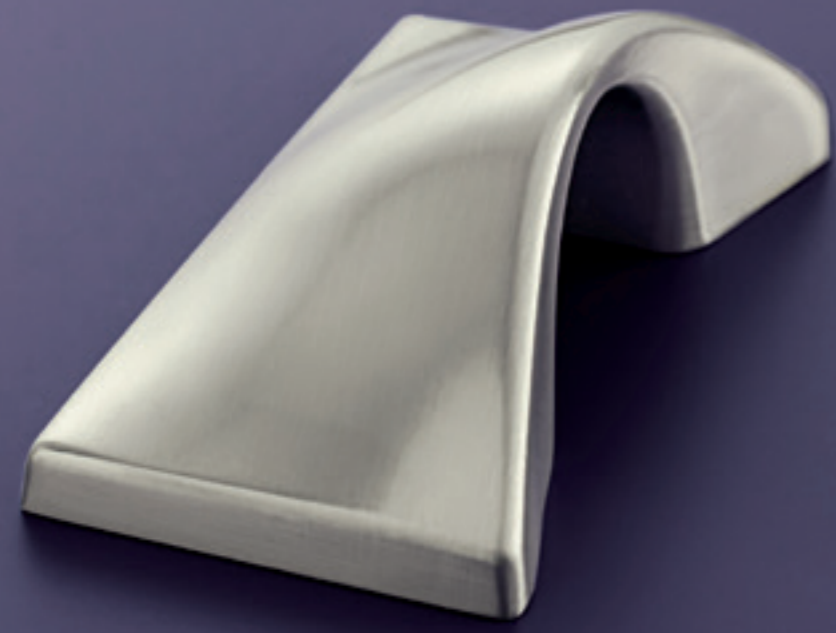

M.112

MUSA

DESIGN: MARCO BORTOLIN



Serie realizzabile in tutte le finiture indicate a catalogo / Series available in all finishes in the catalogue.

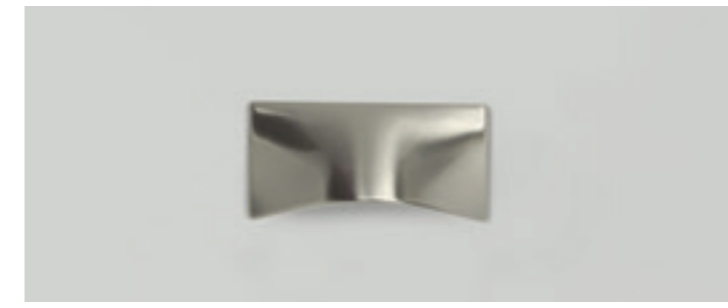
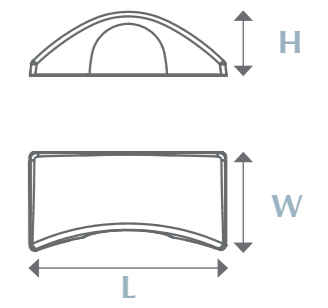

15185Z0320M

L. 60 W. 30 H. 19
O...O 32

Finiture illustrate/ Illustrated finishes:
34 NICKEL SATINATO / SATIN NICKEL INOX ASPECT
36 CROMO LUCIDO / BRIGHT CHROME

Materiale/Material: ZAMA - ZAMAK

Maniglie realizzabili nelle finiture illustrate a fine catalogo.
Handles available in the finishes presented at the end of the catalogue.

M.113

Finiture/Finishes

Crediamo fortemente nella Ricerca e Sviluppo, per questo abbiamo ampliato la nostra gamma con colorazioni ed effetti che, seguendo i trend del momento, donano carattere ed espressione.

We strongly believe in R & D, for this reason we have expanded our range with colors and effects that, following the trends of the moment, give character and expression.

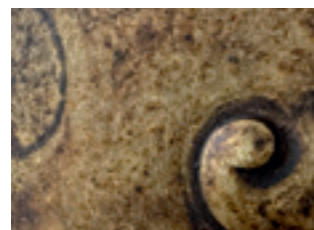

03
Ottone Antico /
Antique brass



12
Ottone satinato /
Satin brass

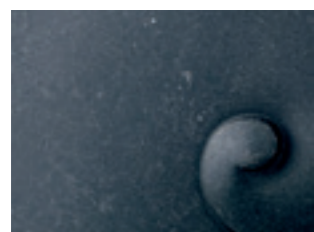

05
Brunito / Burnished

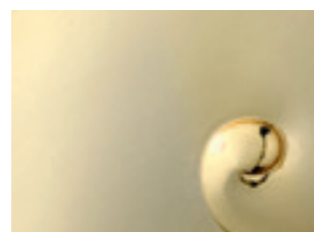

15
Bagno Oro /
Gold plated



06
Patiné France



19
Similferro /
Similiron



07
Oro di Valenza



20
Rustico



09
Florence



22
Old America

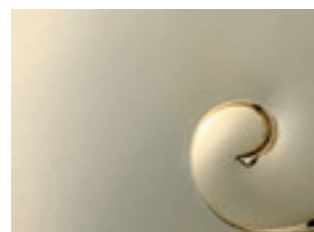

11
Ottone lucido /
Polished brass

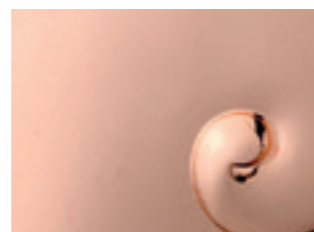

23
Rame Lucido /
Bright copper

Finiture/Finishes



25
Argento Vecchio /
Old silver



36
Cromo lucido /
Bright chrome



28
Patiné Paris



41
Golden White



29
Ramato Antico /
Antique copper



45
Cromo opaco /
Mat chrome

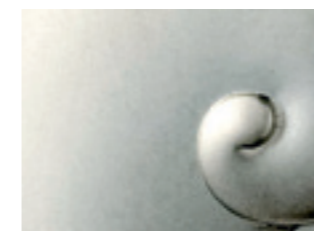

31
Nickel Opaco /
Mat nickel



46
Oro Opaco / Mat gold



32
Nickel lucido /
Bright nickel



47
Argento Orientale /
Oriental silver



34
Nickel Satinato /
Satin nickel Inox Aspect



48
Canna di Fucile

Finiture/Finishes



52
Silver White



78
Bagno Argento /
Silver plated



54
Patiné BM



82
Kassite



69
Moonlight Silver
100% Silver cover

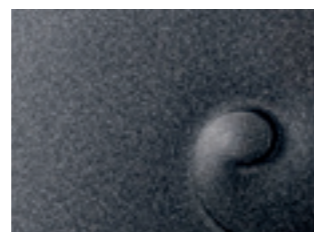

83
Graphite

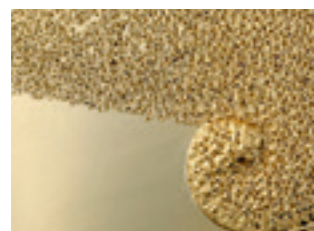

70
Imperial Gold
24 Kt Gold Cover



84
Cromo Satinato /
Satin chrome

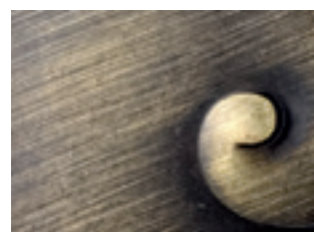

75
Bronze medaille



85
Effetto Titanio /
Titanium effect



76
Cor-Ten effect



87
Old Factory

Finiture/Finishes



90
Terra di Siena



91
Pewter



92
Decapé



93
Velvet gold



94
Iron Effect

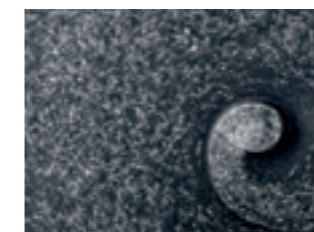

95
Iron Effect Mat



96
Cromo opaco verniciato /
Mat chrome painted

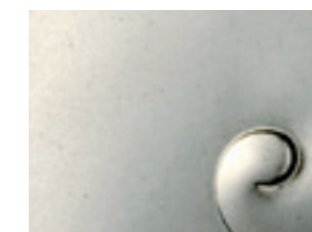

97
Nickel opaco verniciato /
Mat nickel painted



98
Tobacco



DC
Rame satinato /
Brushed copper



DD
Cover silver



DE
Cover copper

Finiture/Finishes



DF
Bright bronze



DN
Rust looking



DT
Gold treasure



N2
Nero opaco /
Mat black - RAL 9005

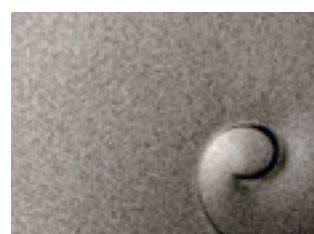

DG
London grey

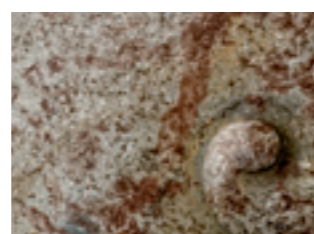

DO
Watery rust



DU
Refined gold 24 Kt



DH
Golden shadow



DP
Ocra vintage



DV
Refined silver



DI
Effetto cemento



DQ
Blue washed



F4
Bianco lucido /
Bright white - RAL 9010



DL
Rock



DR
Ivory gold

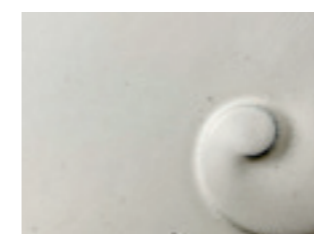

F5
Bianco opaco /
Mat white - RAL 9010



DM
Watery stone



DS
Ottone / Brass



N1
Nero lucido /
Bright black - RAL 9005

Le texture e i colori delle finiture rappresentate hanno valore identificativo in quanto soggetti alle tolleranze dei processi di stampa.
The texture and colors of finishes are not binding because they depend on printing colors tolerances.

I nomi delle finiture sono nomi di fantasia e hanno valore puramente commerciale.
Finishes names are fancy names and have a purely commercial value.